

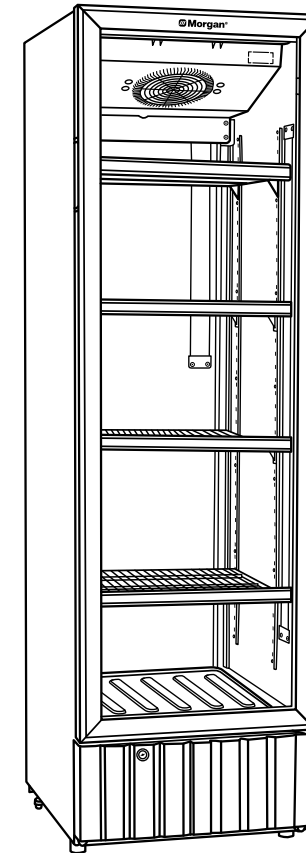

USER MANUAL



Chiller Showcase

MCS-229
MCS-299
MCS-339



E-mail: electrical.appliance@dksh.com
www.morgan.my

facebook.com/morganappliances



CARE AND CLEANING

WARNING: To prevent any electrical shock hazards or injury by the rotating circulation fan, always disconnect the power cord plug from the power supply before proceeding with cleaning and maintenance.

- Exterior and interiors - wipe with a soft, dry cloth. If the showcase very soiled, wipe with a detergent-moistened cloth then wipe with a cloth that has been dipped in water.
- **WARNING:** Do not splash water directly onto the appliance or compressor to prevent short circuit and electrical shock.
- Clean the appliance regularly to maintain cleanliness and hygiene at all times.
- Never use polishing powder, soap powder, benzine, oil, acidic or alkaline cleansing agents or hot water as these will damage the painting and plastic components.
- Ensure sufficient space between food items and do not obstruct air vents.
- In the event of a power outage, wait at least 5 minutes before powering on appliance to prevent compressor damage and to ensure longer appliance life.
- If appliance is not to be used for long durations, disconnect power, clean and allow to dry naturally before storing away.

DEFROSTING

- Defrosting will occur when the compressor stops operation, resulting in an increase in temperature.
- Defrosted water will flow to the water box from the compressor via a drainage hose.
- Water inside the water box will vaporize by the heat of the operating compressor and there is no need for manual defrosting.

LAMP

- The lamp switch is placed beside the control panel.
- Select "0" to turn lamp off, and "1" to power light on.
- For lamp replacement - contact your authorized service agent or a similarly qualified technician. Do not attempt to repair yourself!

IMPORTANT SAFEGUARDS

- To protect against the risk of electric shock, do not immerse power cord, power plug or unit in water or any other liquids.
- Unplug from power supply when not in use and before cleaning. Allow to cool completely before assembling/disassembling parts, and before cleaning appliance.
- Beware the risk of glass breaking when moving or transporting the appliance. Do not forcibly press or pull on the glass door as it can be easily damaged.
- This appliance is intended for indoor use only. Do not place the appliance in a location exposed to rain which could result in electrical leakage and electrical shock.
- Keep appliance away from hot air areas such as hot plates, stoves or direct exposure to sunlight as these could reduce cooling performance.
- Never store flammable or volatile substances into the appliance as this might result in explosion or fire.
- Never use flammable spray cans or leave flammable substances (gasoline or petrol) near the appliance. Sparks from electrical switches could result in explosion and fire.
- Never place heavy objects or items that contain water on top of the showcase to prevent them from toppling over and cause injury. Spilled water could deteriorate the insulation of electrical components and result in electrical leakage.
- Do not operate the appliance in the event of gas leakage. Turn off the appliance immediately and open the door for ventilation. Gas leakage could cause explosion and fire.
- Install the appliance on a location where the floor is stable enough to support the load of the appliance. Failing to do so could result in the appliance to tip over and falling shelves and products could cause personal injury.
- Ensure not to place the appliance in a location where children play and can be easily reached by them. This will minimize the risk that a child being trapped inside the appliance.
- Ensure there is more than 10cm space between the appliance and the wall. Cooling performance could be affected if there is no sufficient ventilation.
- CAUTION: Never store hot foods immediately to avoid damaging the appliance.
- **WARNING:** Keep all ventilation openings clear of obstruction.
- **WARNING:** Do not use mechanical devices or other means to accelerate the defrosting process, other than those recommended by the manufacture.
- **WARNING:** Do not damage the refrigerant circuit.
- Never splash water directly onto the appliance or wash with water as this action could result in short circuit and electrical leakage.
- All repairs, disassembly and modifications should be performed by qualified technicians. Attempting to perform these yourself could result in a fire, malfunction, and injury.
- Use a dedicated power supply. Do not operate with extension cords as this could result in electrical shock, overheating or fire.
- The use of accessory attachments not recommended by the manufacturer may result in fire, electrical shock, or risk of injury to persons.

PARTS IDENTIFICATION

The following is only meant for reference. Please note that actual parts and features may differ.

1. Light
2. Shelf
3. Body
4. Glass Door
5. Key Lock
6. Adjustable Levelling Leg

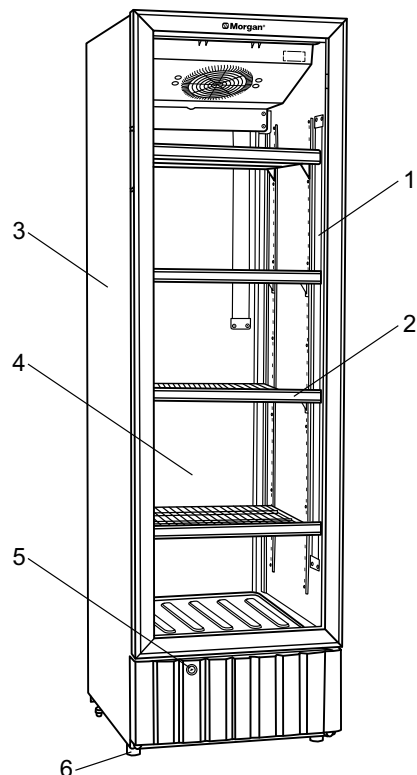

BEFORE FIRST USE

- Be sure to inspect every accessory and part after opening the packaging.
- Properly insulate the appliance and ensure incline does not exceed 45° during transportation to avoid the damaging cooling system.
- Ensure placement of appliance on a solid, stable and horizontal surface for optimum operation and for safety.
- Remove the safety plastic plug jacket before connecting appliance to the power supply. Do not store food items immediately upon appliance startup. Allow appliance to operate for some time before storing food items inside.

OPERATING INSTRUCTIONS

- Place the appliance on a solid, sturdy and horizontal position. Keep the appliance door open for proper ventilation.
- Clean appliance using a clean and moist cloth.
- Connect appliance to the power supply.
- Allow appliance to operate empty for some time.
- Set desired operational temperature by using the thermostat (see "About the Thermostat" below).
- CAUTION: Accessible surface may be hot after compressor has operated for some time.
- For best results, it is recommended for appliance to achieve optimal inner temperature before placing food items inside.

ABOUT THE THERMOSTAT

- The inner temperature inside the appliance is controlled by the thermostat on the panel. The thermostat can set a range of ambient temperatures suitable for different quantities of items.
- On the thermostat knob, there are positions from 0 to 7.
- (Note: Position 0 - 7 depict refrigeration levels, not temperatures.)
- **Position 1** = Highest temperature setting.
- **Position 7** = Lowest temperature setting (keeps cooling all the time).
- **Position 0** = The compressor stops operating.
- To prevent cold air from escaping the appliance, open and close the door immediately after using.

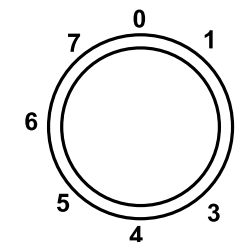

SPECIFICATIONS

MODEL NO.	MCS-229	MCS-299	MCS-339
RATED VOLTAGE	220-240V~		
FREQUENCY	50Hz		
RATED WATTAGE	190W	210W	220W
CAPACITY	190L	240L	280L
REFRIGERANT	R600a/50g		

Thank you for purchasing a quality MORGAN appliance. We trust that you will have a pleasant experience with your new product. To guarantee safety and best efficiency, please read this manual carefully and keep a copy for future reference.

SAFETY PRECAUTIONS

To ensure proper operation, please pay attention to these SAFETY PRECAUTIONS before operating the showcase to minimize risks that could cause serious damage and injury to you or third parties.

 **WARNING!** Improper handling of the showcase could lead to death or serious injuries.

 **CAUTION!** Improper handling of the showcase could lead to serious damage to appliance.

 Strictly adhere to prohibitive action(s)

 Strictly adhere to permissible action(s)

 **WARNING!** High temperature

IMPORTANT SAFEGUARDS

When using electric appliances, basic safety precautions should always be adhered to, including the following:

- Read all instructions carefully and retain them for future reference.
- Before connecting to the power supply, ensure that the unit is earthed, and its voltage corresponds to the voltage indicated on the power supply rating label.
- The rated voltage is 220-240V~. The rated frequency is 50Hz. The compressor will be damaged if operating voltage is too high or too low.
- Do not use appliance for other purpose than intended as this could adversely affect items placed inside.
- The appliance must always be positioned horizontally during use.
- Children should be supervised to ensure that they do not play with the appliance.
- This appliance can be used by children aged from 8 years and above and persons with reduced physical, sensory, or mental capabilities or lack of experience and knowledge if they have been given supervision or instruction concerning use of the appliance in a safe way and understand the hazards involved. Children shall not play with the appliance. Cleaning and user maintenance shall not be made by children unless they are older than 8 and supervised.
- Keep the appliance and its power cord out of the reach of children under 8 years old.

TROUBLESHOOTING

Perform the following troubleshooting services if you encounter problems with the appliance. If the problem persists, disconnect the power cord from the power supply and contact your authorized service agent. Do not attempt to repair the appliance yourself.

CAUTION: To prevent any electrical shock hazards, do not disconnect the power cord or power plug from the power supply with wet hands.

PROBLEM	SOLUTIONS
No Cooling	<ul style="list-style-type: none"> • Check if there is a power cut. • Check if the power plug is properly connected to the power supply. • Check if the fuse is switched off. • Check if the power surge protector is activated. <i>(If appliance has a power surge protector)</i>
Cooling Problems	<ul style="list-style-type: none"> • Check for ideal thermostat position. • Check if the appliance is exposed to direct unlight or placed near heat sources. • Check for obstructions (dirt, dust, grime) on the compressor and condenser. • Are there too many stored items inside? Remove some if there are. • Ensure sufficient space between stored items. • Are there hot food items stored inside? • Is the appliance door opened frequently? • Check if the appliance door is fully closed. • Is frost on the inner cabinet too thick?
Appliance is not operating	<ul style="list-style-type: none"> • Thermostat may be set on high temperature. • Too many food items inside the appliance. • Ambient temperature may have been set too high.
Noise & vibrations	<ul style="list-style-type: none"> • Ensure ground is flat, stable and sturdy. • Ensure appliance is not placed too close to walls. • Ensure appliance is not in contact with object(s).