

## USER MANUAL

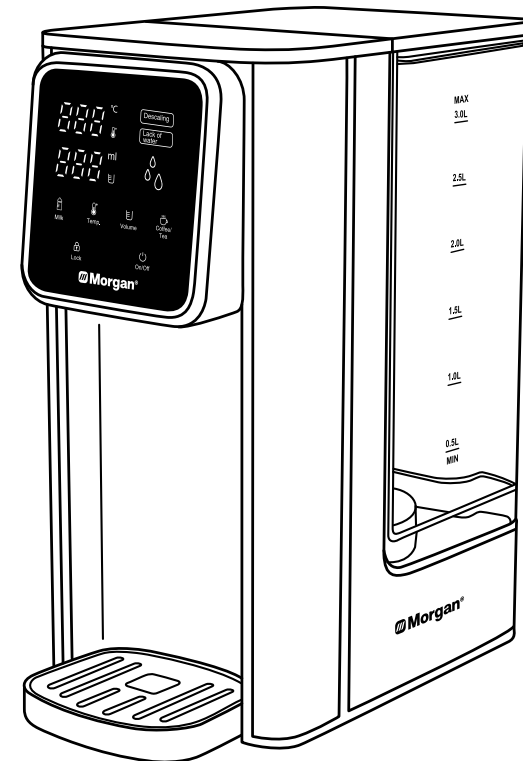

# Instant Boiler

With Removable Water Tank

MIB-6619



E-mail: [electrical.appliance@dksh.com](mailto:electrical.appliance@dksh.com)  
[www.morgan.my](http://www.morgan.my)

 [facebook.com/morganappliances](https://facebook.com/morganappliances)

# C O N T E N T S

**3** Important Safeguards

**4** Specifications

**5** Parts Identification

**5** Control Panel

**6** Operating Instructions

**7** Care and Cleaning

Thank you for purchasing a quality MORGAN appliance. We trust that you will have a pleasant experience with your new product. To guarantee safety and best efficiency, please read this manual carefully and keep a copy for future reference.

## IMPORTANT SAFEGUARDS

**When using electric appliances, basic safety precautions should always be adhered to, including the following:**

- Read all instructions carefully and retain them for future reference.
- Before connecting to the power supply, ensure that:
  - the unit is earthed and its voltage corresponds to the voltage indicated on the power supply rating label.
  - the power cord, power plug and control panel are not damaged, and the housing is not cracked or deformed. Contact your authorized service agent if any other these are present.
- Do not operate the appliance with water below the minimum water level to avoid damaging the heating elements.
- Do not allow the power cord to hang over the edge of table or counter, and/or touch hot surfaces.
- Do not place the appliance on or near any gas or electric burner or inside heated ovens.
- Do not place the appliance into an operating disinfection cabinet.
- Do not store the appliance in a refrigerator.
- Do not lean the appliance or operate it upside down
- Do not use it outdoors.
- This appliance is not intended for use by persons (including children) with reduced physical, sensory or mental capabilities, or lack of experience and knowledge, unless they have been given supervision or instruction concerning use of the appliances by a person responsible for their safety.
- Children should be supervised to ensure that they do not play with the appliance.
- Please ensure the appliance is used on a firm and flat surface out of children's reach, and to prevent it from overturning.
- To protect against fire, electric shock or other personal injuries, do not immerse any part of the appliance in water or other liquids.
- Do not touch hot surfaces and water spout when the appliance is operating
- To avoid scalds or other body injuries from hot escaping steam, do not cover the steam outlet with hand or other objects, and do not open the water tank cover in a rush.
- Do not use the appliance to heat anything other than water.
- Do not fill above the "max" level. Do not operate if water is below the "min" level.

## IMPORTANT SAFEGUARDS

- Always disconnect the appliance from the power supply and allow it to cool down completely before performing cleaning and maintenance.
- If the supply cord is damaged, it must be replaced by the manufacturer or its service agent or a similar qualified person in order to avoid any hazard.
- Do not operate the appliance in the event of a malfunction. Return it to the nearest authorized service agent or manufacturer for examination, repair or replacement. Never attempt to disassemble it yourself.
- This appliance is intended to be used in household and similar locations such as:
  - staff kitchen areas in shops, offices and other working environments;
  - farm houses;
  - by clients in hotels, motels and other residential type environments;
  - bed and breakfast type environments.
- **WARNING:** Misuse may cause injury.
- This appliance shall not be used by children. Keep the appliance and its cord out of reach of children.

## PARTS IDENTIFICATION

1. Control Panel
2. Spout
3. Drip Plate
4. Drip Tray
5. Water Tank Cover
6. Removable Water Tank
7. Bottom Cover

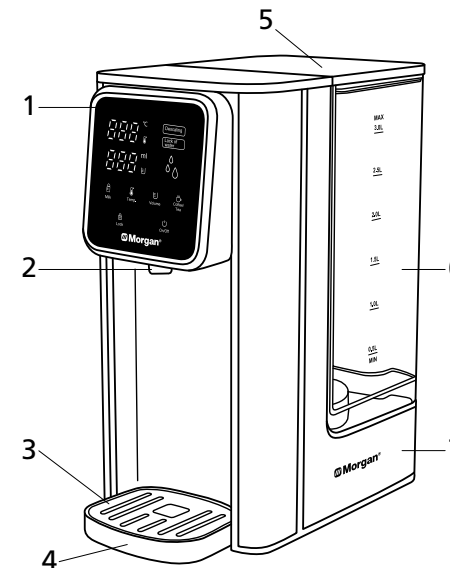

## SPECIFICATIONS

<b>Model</b>	<b>MIB-6619</b>
<b>Rated Voltage / Frequency</b>	<b>220-240V~ 50/60Hz</b>
<b>Rated Wattage</b>	<b>2200-2600W</b>
<b>Capacity</b>	<b>3.0L</b>

## CONTROL PANEL

- Press and hold down the LOCK button for about 3-5 seconds to unlock. Auto lock will activate if there is no activity within 10 seconds. The Control Panel screen can be unlocked by pressing the LOCK button.
- Temp. button: Set the desired temperature according to 000(normal temperature water): 45°C / 55°C / 65°C / 75°C / 85°C / 100°C.
- Volume button: Set the water volume according to 100ml / 200ml / 300ml / 400ml / 000 (continuous flow water)

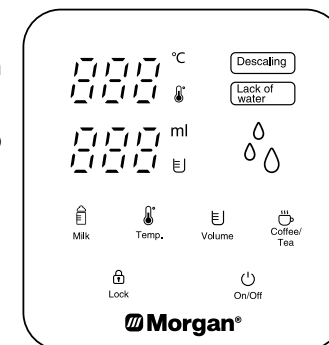

- Milk button: Pour the desired amount of milk powder into a bottle or cup and press MILK button. Temperature will indicate 40°C and select the desired volume 100ml / 200ml / 300ml / 400ml / 000 (continuous flow water). Press ON/OFF button to operate.
- Coffee/Tea button: Pour the desired amount of coffee powder or insert tea bag in a bottle or cup. Press the COFFEE/TEA button. Temperature will indicate 92°C and select the desired volume 100ml / 200ml / 300ml / 400ml / 000 (continuous flow water). Press ON/OFF button to operate.
- Press ON/OFF button to start or stop function setting.

# OPERATING INSTRUCTIONS

## BEFORE FIRST USE

- Clean the water tank before first use.
- Disconnect power plug from the power supply.
- Fill water tank with clean water and discharge before refilling with clean water once more for normal operation.

## FILLING WATER

1. Open the water tank lid, fill the water tank with the desired amount of water, and then close the lid. Note: the water level must be less the "Max" level. You can select two methods as per the following:

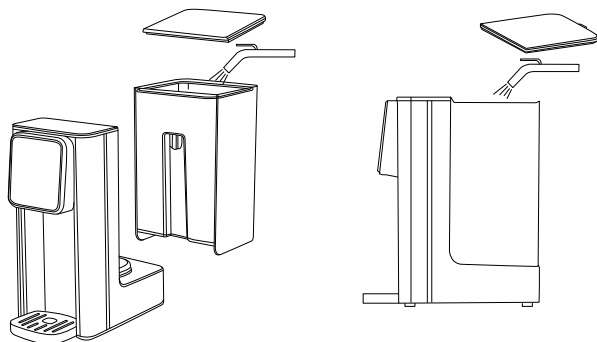

## 2. OBTAIN DESIRED WATER

- Connect power plug into the power supply and fill the desired amount of water.
- Place a cup on the removable water tray, ensuring it aligns with the spout.
- Select the desired temperature and volume and press the ON/OFF button to operate the appliance.
- The water spout will dispense water continuously in about 5-10 seconds.
- Press the ON/OFF button stop / begin dispensation.

## REMARKS

- Do not touch the boiled water and steam in order to protect against scalding by boiled water and hot steam.
- Safety cut-out: If the appliance stops operating with a beep sound and the PCB panel shows the E7 symbol, this means there is insufficient water inside the water tank. Please fill the water tank below the "Max" level.
- The appliance can memorize the last operation method until the plug is disconnected.
- As the appliance has memory function when powered on, it is recommended to use about the first 60 seconds to obtain the desired water temperature. When switched off the memory will reset.
- As ambient temperature fluctuates every day, the water volume will undulate within -15% to +15%.

# OPERATING INSTRUCTIONS

## NOTE:

- The appliance features a manual thermostat to recover the heating function during abnormal operation.
- If there is no power supply to the appliance, the appliance has stopped operating, or water is not boiling, the thermostat can be reset by inserting the reset key into the reset button hole located at the back of the appliance.

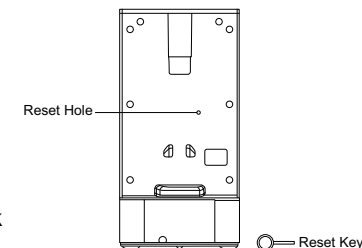

# CARE & CLEANING

- Always switch off, disconnect the appliance from the power supply and allow it to cool completely before cleaning.
- Do not immerse the appliance into any liquids to avoid damaging the appliance.
- To ensure optimal performance, it is recommended to descale the appliance when the "Descaling" symbol is flashed on the control panel display.
- Use only toxic free detergent such as citric acid or vinegar.
- Add some citric acid or vinegar into the water tank and fill water until the "Max" level.
- Operate under 100 °C setting at volume 000 for 2 - 3 times to eliminate any limescale.
- After completion, discard the boiled water and add clean water to boil before drinking.
- Do not use any chemical, metal, wood or abrasive detergent to clean the appliance housing. Use a damp cloth only.
- Always handle the appliance gently, do not place it near the edge of the table and countertops to protect against deformation or damage in the event of it toppling over.

## REMARKS

- After cleaning the appliance, open the drainage stopper to discard any water remnants.

**Note: Tighten the drainage stopper after opening it.**

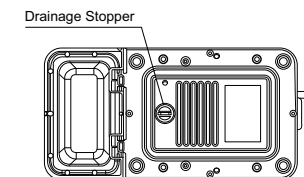

## DISPOSAL OF WATER WHEN WATER TRAY IS FULL

- Grasp the appliance with one hand, and another hand to slightly lift up to detach the water tray. Empty the water tray and insert it into its original position.

## STORAGE

- If the appliance is not to be used for a long duration, unplug and clean it, and then store it into its packing box to avoid damaging or humidifying the electrical components.

