

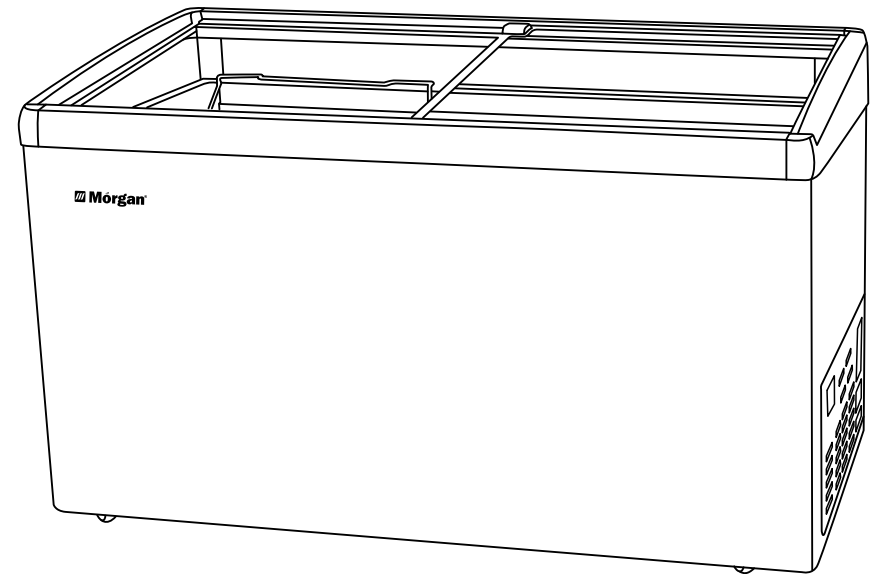

Morgan®

USER MANUAL

Morgan®



E-mail: electrical.appliance@dksh.com
www.morgan.my

 facebook.com/morganappliances

Chest Freezer

MCF-G516L
MCF-G456L
MCF-G336L
MCF-G256L

Thank you for purchasing a quality MORGAN appliance.

We trust that you will have a pleasant experience with your new product. To guarantee safety and best efficiency, please read this manual carefully and keep a copy for future reference.

SAFETY LABELS & WARNINGS

1. Food Basket
2. Glass Door
3. Body
4. Control Panel
5. Wheel

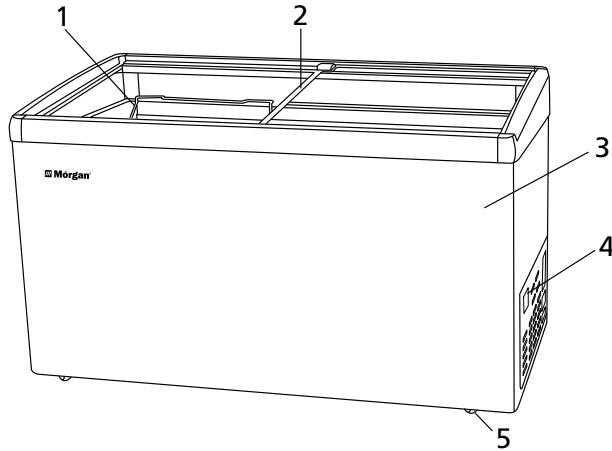

NOTE: Actual product specifications may vary, and all features, functionality and other product specifications are subject to change without notice or obligation.

PRODUCT FEATURES

- Extra thick foam for super heat insulation
- Deep body for higher storage capacity
- Safety lock (optional)
- Green refrigerant: non-HFC & FCKW
- Innovative design
- Fast freezing function
- Zintec coated anti-rust
- Low power technology

SAFETY LABELS & WARNINGS



This symbol indicates information that, if ignored, could possibly result in personal injury or even death due to incorrect & improper handling.



This symbol indicates information that, if ignored, could result possibly in personal injury or physical damage due to incorrect & improper handling.



This symbol indicates a prohibited action.



Proper & recommended actions must be strictly adhered to at all times.



High temperature & burn hazard warning

SAFETY PRECAUTIONS

IMPORTANT SAFEGUARDS

When using electric appliances, basic safety precautions should always be followed including the following:

- This unit is not intended for use by persons (including children) with reduced physical, sensory or mental capabilities or lack of experience and knowledge, unless they have been given supervision or instruction concerning use of the unit by a person responsible for their safety.
- Do not operate unit with damaged power cord or power plug or after the unit malfunctions or has been damaged in any manner. In such a situation, it is recommended to return the unit to your nearest Authorized Service Centre for examination, repair, or adjustment.

Before connecting to the power supply, ensure that the unit is well-earthed with a 3-wire power socket and 10A or higher fuse. Ensure the power voltage corresponds to the voltage indicated on the power supply rating label at the bottom of the appliance.

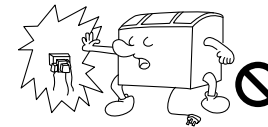

The power socket must be earthed and preferably equipped with a power leakage protector. Ensure that it is not connected to any gas or water pipe, telephone cable or lightning rod.

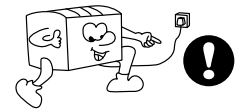

CAUTION: Do not wet the power cord or handle the power plug with wet hands.

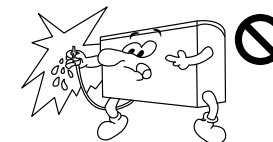

In the event of a malfunction, disconnect the power cord from the power supply. Ensure the problem is rectified before connecting to the power supply to avoid a fire or power hazard.

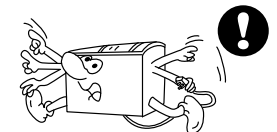

SAFETY LABELS & WARNINGS

Always connect and disconnect from the power supply correctly. When connecting, ensure good connection between the power plug and power supply socket. When disconnecting, detach only the power plug and do not pull on the power cord to avoid loosening or damaging it.



Do not squeeze, fold, knot or damage the power cord in any manner. If the power cord is damaged, it must be returned to your nearest Authorized Service Centre for examination, repair, or adjustment to avoid a fire or power hazard.

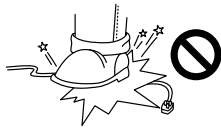

Do not spray or wash the unit or place it in moist or damp places with close contact with water as doing so may affect the unit's electrical insulation properties.

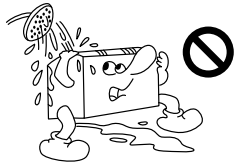

Detach the power plug from the power supply when cleaning to avoid electric shocks.

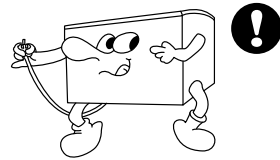

If there is a flammable gas leak, such as natural gas around the appliance, open the window and to let the gas escape. Do not connect appliance to the power supply or close the thermostat to avoid an explosion caused by a short circuit.

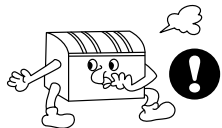

Do not store flammable liquids, explosive, and corrosive items inside the unit such as acids, alkali, and other hazardous materials.

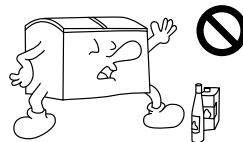

When the appliance is not used for long periods, store the appliance away from children play, and remove the door seal to avoid asphyxia if children are trapped inside the cabinet.



Children should be supervised to ensure that they do not play with the unit.



CAUTION: Flammable refrigerant and foaming material. When disposing the appliance, do not expose it to fire or fire sources. This appliance should be recycled by appointed institutions. Personal handling may cause danger.

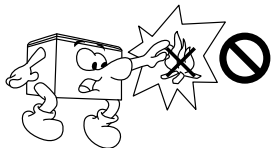

MISSED - Do not spray flammable agents near the appliance to avoid the risk of fire or explosion.

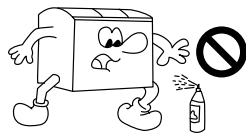

SAFETY PRECAUTIONS

CAUTION: Do not damage the refrigerant circuit.

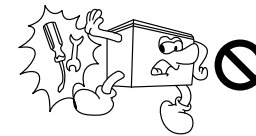

CAUTION: This appliance must be installed correctly according to instructions due to its instability.

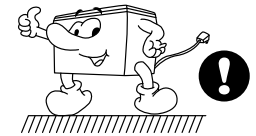

CAUTION: Glass door is fragile. Do not forcibly press and/or pull on the glass door when moving or transporting the unit.

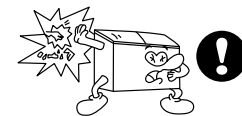

Do not touch the bare pipes or wires to avoid a potential scald or electrical shock.

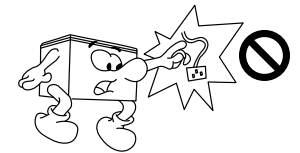

Operating voltage should be 220V +10% /-15 %. That is from 187V to 242V. The compressor can be damaged if operating voltage is too low or too high.

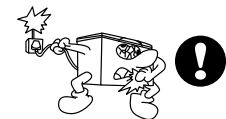

Disconnect the power plug from the power supply if the appliance is not to be used for a long time.

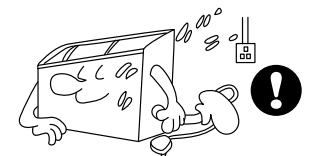

CAUTION: Avoid touching any pipes or electrical parts inside the appliance to avoid burns or scalds as they are operating at high temperatures.

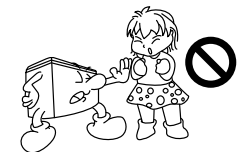

Do not spray or wash the unit or place it in moist or damp places with close contact with water as doing so may affect the unit's electrical insulation properties.

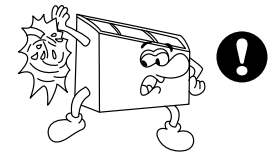

WARNING: Do not touch internal refrigerant pipes to avoid low temperature burns and scalds.



It is not advisable to store medicines or other items that require precise storage temperatures.

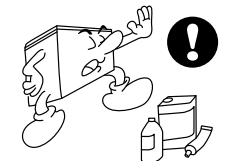

SAFETY PRECAUTIONS

Do not store bottles, cans or other fragile items in the unit because they may explode under -18°C.



To ensure freshness for fruits and vegetables, do not overload the maximum storage capacity.

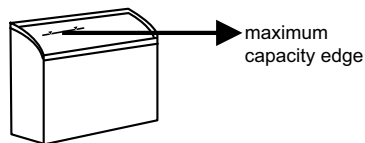

WARNING: Keep all ventilation openings free from obstructions.

WARNING: Do not use mechanical devices or other means to accelerate the defrosting process other than those recommended by the manufacturer.

WARNING: Do not operate electrical appliances inside the appliance's food storage compartments unless they have been recommended by the manufacturer.

Disconnect power from the power supply and remove all stored items before moving or transporting the appliance to avoid accidental body injuries or equipment damage.

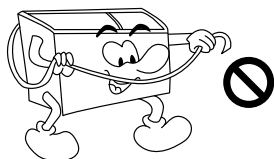

WARNING: Touching hot surfaces during or directly after operation may result in burns, scalds or other bodily injuries.



Remove all stored items inside & disconnect power supply before moving to avoid damaging the appliance or the risk of injuries.

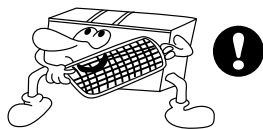

Do not allow small children access to stored items in the appliance to avoid injuries and other accidents.



Remove the flammable bottom polyfoams before operating the appliance to avoid the risk of fire.

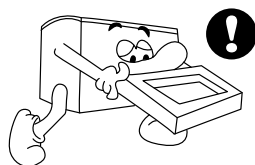

WARNING: Flammable refrigerant may ignite or cause eye injuries!

Contact your Authorised Service Agent to inspect and repair the cooling system in the event of a malfunction.

Do not attempt to disassemble, repair or modify the appliance by yourself to avoid refrigerant leakage.

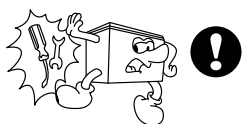

Connect to potable water supply only.



SAFETY PRECAUTIONS

Install the appliance in a dry and ventilated room. Follow the below recommended ventilation clearance:

- from the side panels to wall: 20cm minimum.
- from the back to wall: 20cm minimum.
- from the top to wall or ceiling: 30cm minimum.

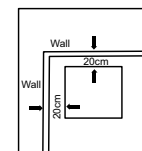

Do not leave the keys to lock/unlock the appliance where young children can access it easily to prevent children from trapped inside it accidentally.

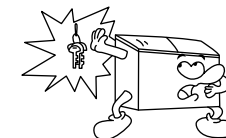

CARRYING & INSTALLATION

Move the appliance carefully and avoid collisions with people or objects.

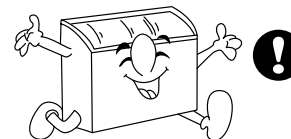

Inspect and pack the appliance according to the original storage positions before moving or transporting.

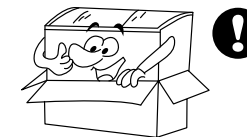

Ensure an incline angle less than 45° during moving/transportation to avoid damaging cooling system.

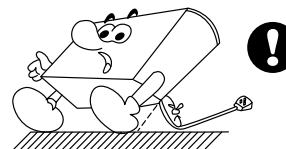

Do not locate the appliance under direct sunlight or near heat sources as doing so may increase the power consumption and damage the plastic parts and surface coatings.

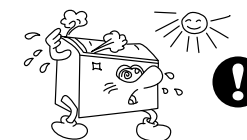

Install the appliance on a flat, sturdy and horizontal surface for a stable installation for extra safety and to prevent excessive noise and vibrations during operation.

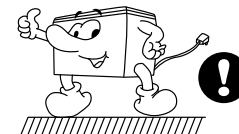

Allow some minimum distance from circumferences for good ventilation and to minimize heat radiation and power consumption.

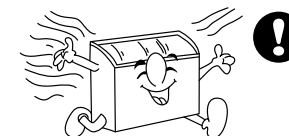

Install the appliance in a dry place. Placing the appliance in a wet or humid environment will expose it to rust and poor insulation. This appliance is intended for indoor use only. Do not install outdoors.

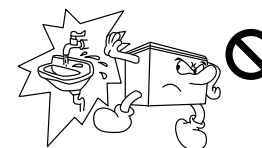

Remove the foam at the bottom for the appliance to cool faster and for better mobility.

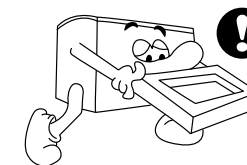

BEFORE FIRST USE

Install the appliance according to instructions and place at the desired location.

Leave the doors open for proper ventilation.

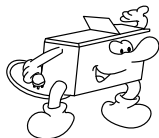

Clean the inner cabinet before first use.

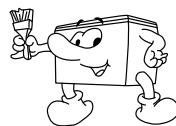

- After installing the appliance, wait for at least 6 hours before powering on the appliance. (During transportation the oil in the compressor may have flowed into the refrigeration system.)
- During initial start-up, the cabinet may be hot and the compressor will work continuously before the thermostat stops at the preset temperature and function optimally.
- It is recommended to store food items into the cabinet once the interior temperature reaches the preset temperature.

CARRYING & INSTALLATION

The cabinet temperature is controlled by the thermostat on the panel. The thermostat can set a suitable temperature range according to different ambient temperatures and different loads.

- The red indicator is the POWER indicator. During POWER on, the red indicator will illuminate.
- The green indicator is the OPERATION indicator. When the compressor runs, the green indicator will illuminate.
- The thermostat knob can be rotated from MIN to MAX.
- When rotating clockwise, cooling time will be longer & stopping time will be shorter. In this way, the cabinet temperature will be lower.
- When rotating anti-clockwise, cooling time will be shorter & stopping time will be longer. In this way, the cabinet temperature will be higher.
- After adjusting the thermostat, it will take some time to reach the optimal performance temperature.

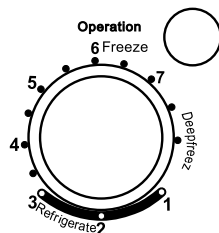
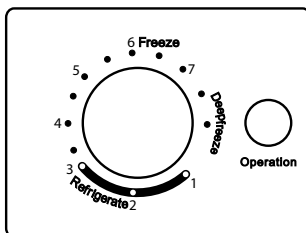

GENERAL OPERATING INFORMATION

Keep some spaces between stored food items to maximise cool air circulation and heat exchange to achieve better cooling effect.

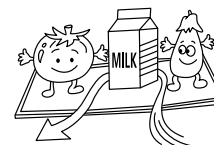

Keep food items fresh by storing in kept bags or closed containers to avoid food smell contamination or from drying out.

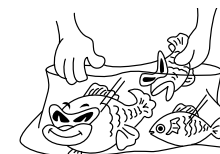

Allow hot food to cool down to room temperature before storing into the appliance to avoid decreasing the cooling level of other stored food items.

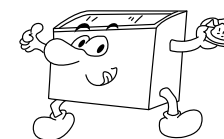

Open the door as briefly as possible & close the door at all times to minimize power consumption.

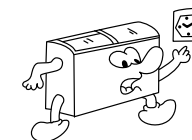

It is recommended to indicate the freeze-in date on every individual pack stored in the appliance. Follow a FIFO (First In, First Out) process to take earlier stored food items first.

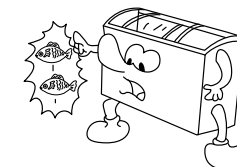

Set different cooling temperatures according to different food items. Extremely cool temperatures will result in excess power consumption.

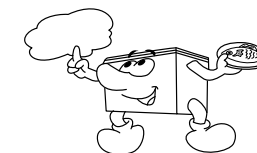

In the event of a power outage or switching off the appliance, always wait at least 5 minutes before restarting. Failure to do so may shorten the compressor life or even damage the compressor.

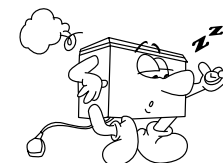

If a power cut has been notified in advance, set the thermostat for a low temperature and keep the appliance cooling for some time. Open the door as briefly as possible and do not add more food items into the appliance.

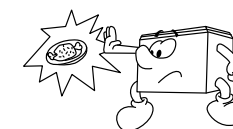

CARE & CLEANING

- Regular cleaning and maintenance can prolong the life of the appliance and increase cooling efficiency.
- Unplug power cord from the power supply and remove all food contents inside the freezer.

Clean the inner cabinet and exterior with a soft cloth using a neutral cleansing agent & warm water.

WARNING: Do not use hot water, corrosive cleaning agents or organic agent as these may damage the finishing.

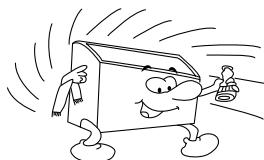

Clean the door seal by using bleach diluted 10 times with water and wipe again with clean water.

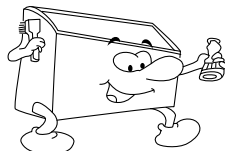

Ensure the following after performing care & cleaning:

- Correct and proper connection between power plug and power supply socket. - That the power plug is not abnormally hot.
- That the power cord is not damaged in any manner.

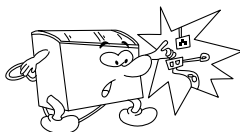

If the appliance is not to be used for a long period - power off, disconnect from the power supply and store in a cool, dry place.

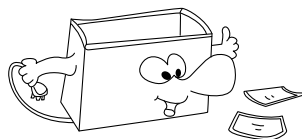

DEFROSTING

Moisture in goods and air will change into frost on the low temperature surface of the evaporator, or the inner surface of the cabinet. The frost will decrease the cooling effect. Defrost if frost thickness reaches 5 ~ 7mm.

- Power off appliance and disconnect power plug from the power supply.
- Remove all stored food items inside the cabinet.
- Open the door, and remove the frost by a special defrosting shovel when the frost gets soft.
- Open the drain hole on the bottom for frost water to flow through the drain hose.
- Wipe off excess frost water, connect power plug into the power supply and power on the appliance.
- Place food items back into cabinet only when temperature reaches the optimal operating temperature.

ATTENTION: Do not defrost by using sharp metal edge tools or electrical heating tools. Doing so may damage the evaporator.

TROUBLESHOOTING

PROBLEM	POSSIBLE CAUSES
No cooling	<ul style="list-style-type: none"> • Check whether there is a power cut. • Ensure proper connection between the power plug and power supply socket. • Check whether the fuse is switched off. • Check whether the power surge protector is operating properly (if appliance is connected to a power surge protector)
Appliance not cooling properly	<ul style="list-style-type: none"> • Thermostat is set correctly. • Appliance is not exposed to direct sunlight or placed near heat sources. • There is no dust on the compressor and condenser. • Cabinet is not overloaded with too many food items. • Adequate space between stored food items. • Stored food items are not hot during storage. • Door is not opened frequently. • Door is completely closed. • Frost on inner cabinet is not too thick.
Compressor operating continuously without stopping	<ul style="list-style-type: none"> • Thermostat may be set on high temperature. • Cabinet is overloaded with food items. • Ambient temperature may be too high.
Noisy operation	<ul style="list-style-type: none"> • Ensure appliance is positioned on a flat and sturdy surface. • Check whether appliance is placed too close to walls or other objects. • Ensure appliance is not in contact with another electrical appliance.

NON-FAULT INSTANCES

The following are normal occurrences and does not necessarily signify a malfunction.

- Frost will appear on the door frame and seal when ambient temperature is set too high or door is rarely opened. Just wipe off the frost water using a clean cloth.
- The appliance has a sound like water current or water boiling. Refrigerant is flowing through the refrigerant hose.
- The compressor and the condenser feel hot during operation.
- The compressor operates continuously without stopping if there are too many food items stored inside.
- Contact your Authorised Service Agent if there is no resolution to the problem.

WARNING: Do not attempt to repair the appliance yourself.