

 **Mórgan®**

 **Mórgan®**

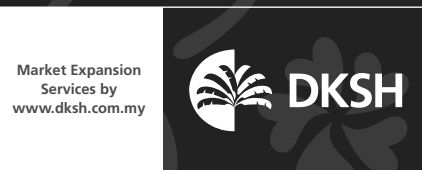

E-mail: electrical.appliance@dksh.com
www.morgan.my

 [facebook.com/morganappliances](https://www.facebook.com/morganappliances)

USER MANUAL

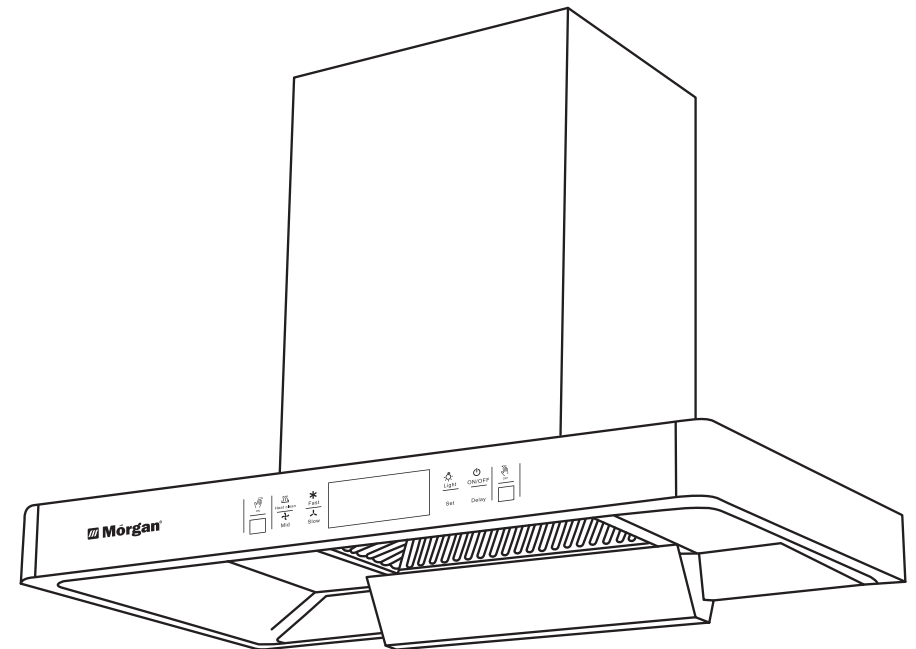

Designer Hood

MDH-936STHC

Thank you for purchasing a quality MORGAN appliance. We trust that you will have a pleasant experience with your new product. To guarantee safety and best efficiency, please read this manual carefully and keep a copy for future reference.

IMPORTANT SAFEGUARDS

When using electric appliances, basic safety precautions should always be followed including the following:

SAFETY PRECAUTIONS

1. Read all instructions carefully and retain them for future reference.
2. Before connecting to the power supply, ensure that the unit is earthed and its voltage corresponds to the voltage indicated on the power supply rating label.
3. Always disconnect appliance from the power supply when not in use or before cleaning.
4. It is recommended to use a dedicated power socket that is not shared with other electrical appliances.
5. To protect against electric shock, do not immerse power cord, power plug, or any parts of the unit in water or other liquids.
6. Do not operate the appliance with a damaged power cord or power plug or after it malfunctions or has been damaged in any manner. In such a situation, it is recommended to return the unit to your nearest Authorized Service Centre for examination, repair, or adjustment.
7. Ensure the power cord is not exposed to heat, chemicals, sharp objects or anything that may damage or affect its performance.
8. Ensure adequate ventilation of the room where the cooker hood is used.
9. Exercise extreme caution when operating the cooker hood in the same room or the same area of the house at the same time as another heating appliance that depends on the air from the room.
10. **WARNING:** Risk of fire if cleaning is not carried out in accordance with the instructions given in this manual.
11. Do not flambe under the cooker hood.
12. The air must not be discharged into a flue that is used for exhausting fumes from appliances burning gas or other fuels (not applicable to appliances that only discharge the air back into the room).
13. This appliance can be used by children aged from 8 years and above and persons with reduced physical, sensory or mental capabilities or lack of experience and knowledge if they have been given supervision or instruction concerning use of the appliance in a safe way and understand the hazards involved.
14. Children should not be allowed to play with the appliance. Cleaning and user maintenance shall not be made by children.
15. Keep the appliance and its cord out of reach of children.

INSTALLATION

- This appliance must be installed or repaired by a qualified technician only.
- **WARNING:** It is dangerous to modify any part of this appliance.
- The manufacturer declines all responsibility in case of failure to adopt proper safety measures.
- Ensure the location in which this appliance is installed has good, permanent ventilation.
- In ducted mode, ensure one or more permanent air inlet. The air collected must not be discharged into a duct used to blow off smoke from other electricity-driven appliances.

IMPORTANT SAFEGUARDS

- The distance between the bench to the lower part of the hood must not be less than 60cm.
- Ensure that the unit is earthed and its voltage corresponds to the voltage indicated on the power supply rating label.
- Do not connect the hood to a duct that discharges combustion fumes (e.g. fireplace).

OPERATION

This product is designed for household use only and should never be used for commercial application.

- After use, always ensure that all controls are in the "OFF" position.
- When frying with a gas flame, exercise caution not to allow oil or grease in the pan to catch fire.

MAINTENANCE

- Clean the grease filters often at least once monthly.
- Heavy oil deposits can pose a fire hazard. Hood surface should be cleaned with soft cloth and non-corrosive detergent.
- **Important:** Never attempt to repair this appliance by yourself. Always consult an authorized Service Technician.
- For your safety, always insist on original parts.
- Always switch off the power and disconnect from the power supply before conducting maintenance or cleaning.

DUCTED OR RE-CIRCULATING MODE

Depending on your requirement, this appliance can be configured to operate in the ducted or re-circulating modes.

- **DUCTED MODE:** Fire proof ducting system of 180mm diameter vent the fumes through a suitable outlet. In ducted mode, only the aluminium grease filters are installed.
- **RECIRCULATING MODE:** Fumes are filtered for grease and odour through the aluminium grease filters and the charcoal filters respectively and re-introduced into the kitchen environment.
- In re-circulating mode, both the aluminium grease filters and the charcoal filters should be installed.

SPEED CONTROL

The hood is equipped with a 3-speed electronic control. Use:

- Low speed for simmering.
- Medium speed for light cooking.
- High speed for frying or heavy cooking.

PARTS IDENTIFICATION

1. Chimney
2. Control Panel
3. Filter Assembly
4. Oil Collector
5. Air duct assembly

INSTALLATION KIT INCLUDES:

- Install screws package
- User instructions
- Main unit Back hanger

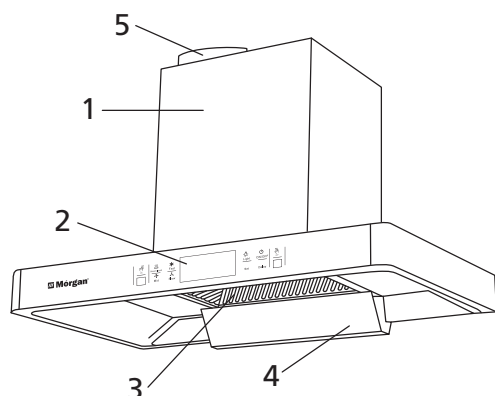

OPERATING INSTRUCTIONS

TOUCH CONTROL AND MOTION CONTROL

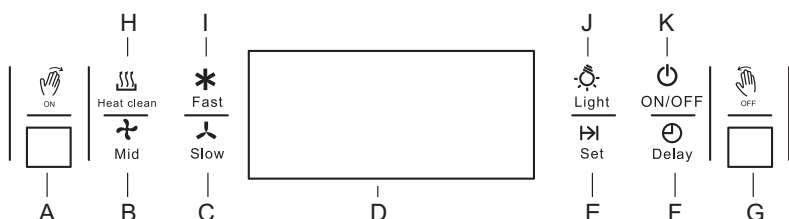

1. (A) is the switch to power on Motion Control. The fan will operate when a hand gesture swipes to the right about 10cm from (A). Lights and (D) LED screen will power on simultaneously.
2. (B) is to select the Mid fan speed.
3. (C) is to select the Slow fan speed.
4. (D) The LED screen will display Time, Fan speed or Time for auto-heat cleaning.
5. (E) is to set the clock. Touch the "Set" button, both the "Fast" and "Slow" buttons will be illuminated, and the clock will appear on the LED and start flashing. Touch "Fast" and "Slow" button to set time.
6. (F) is to select delay time to switch off the appliance. Touch the "Delay" button when the fan is on (any speed), a run down clock will display on the LED and the hood fan will automatically turn off after 60 seconds. Lights will be turned off simultaneously.
7. (G) is Power OFF switch for Motion Control. The unit will power off when a hand gesture swipes to the left about 10cm from the (G).
Note: This function will not be activated when the unit is on auto-heat cleaning.
8. (H) is Heat auto-cleaning function. Press (H) key for 2 seconds to start Heat auto-cleaning function when the heat auto cleaning is in operation. The unit will divert the oil into the inner housing in 10 minutes. Press (H) again to cancel the function.
9. There are 3 fans speed levels. (I) high speed, (B) medium speed and (C) is low speed.
10. (J) is the ON/OFF light switch.
11. (K) is the Power ON/OFF switch for Touch control. Press it to power on the unit. Press it again to power off.

CARE & CLEANING

ALWAYS SWITCH OFF AND DISCONNECT FROM POWER SUPPLY!

SURFACES

- Wash with warm soapy water and a soft sponge.
- Never use abrasive detergent, scouring pads, steel wool or solvents on any part of this appliance as this will damage the finishing.

ALUMINIUM GREASE FILTERS

- Wash with soapy warm water or soak in a degreasing agent for an hour, then rinse off and dry before re-installing.

CHARCOAL FILTERS

(for recirculating model only):

- The charcoal cannot be reused and must be replaced once a year or depending on the frequency of operation.
- Regular maintenance is mandatory for this appliance to function effectively as clogged filters may restrict airflow and may cause the motor to overheat.

INSTALLATION

1. Use suitable bolts to mount the appliance on a secure surface.
2. The minimum distance between the supporting surface for cookware on the hob and the lowest part of the range hood with the cooker hood located above a gas appliance should be at least 65 cm. If the instructions for installation for the gas hob specify a greater distance, this has to be taken into account;
3. Ensure the location of the installation has permanent openings for ventilation.
4. Regulations concerning the discharge of air have to be fulfilled.
5. It is strongly recommended that the cooker hood be installed right over the exhaust air from cooking.
6. It is not recommended to install the pipe outlet in the wind direction, which can prevent the exhaust air from flowing backwards.
7. Fasten the exhaust outlet components securely with screws. To ensure good ejection of exhaust air, do not bend the pipe excessively.

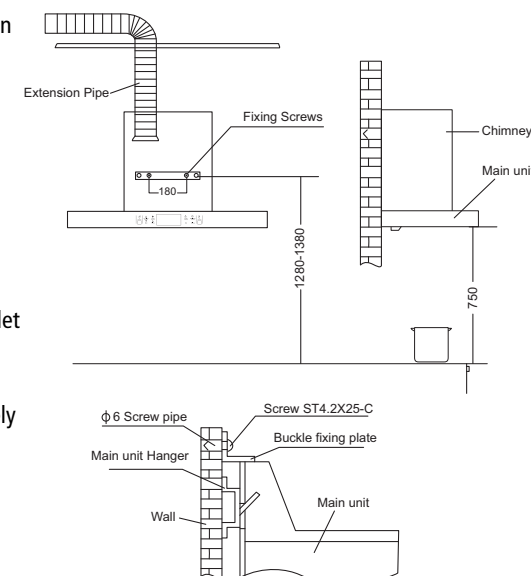

INSTALLATION

- Insert the inner chimney into the upper chimney and pull upwards. Adjust to reach the height required.

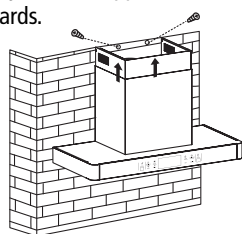

- Secure the lower chimney with 2 pcs of 4x8mm screws.

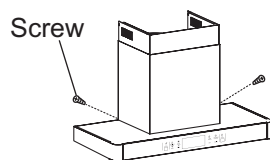

- Slide the chimney to adjust the chimney height. When the desired height is achieved, secure it with 2 pcs of 4x8mm screws onto the holes as illustrated in Plate I below.

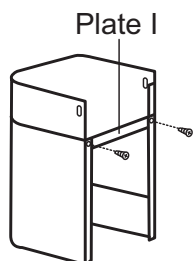

- Drill 2 x 8mm holes to accommodate Plate II. Secure and tighten Plate II onto the wall with the 2 screws provided.

- Assemble the chimney onto the unit and secure it with 2 screws.

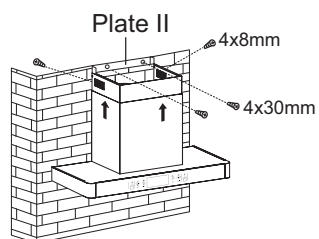

INSTALLATION (VENT INSIDE)

- An exhaust pipe is not required if there is no external exhaust outlet. See similar installation method as in "Installation (Vent outside)".

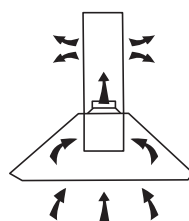

HOW TO INSTALL CHARCOAL FILTER (For Recirculation System model only)

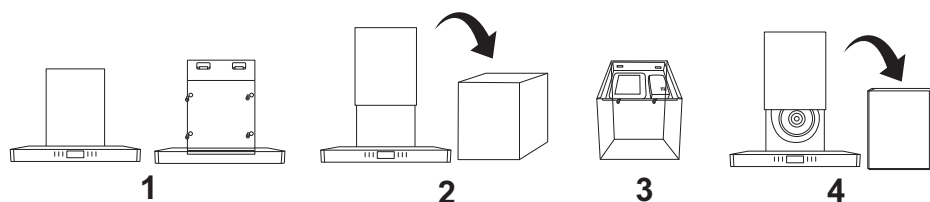

- Unscrew the four (4) screws on the back of the chimney hood.
- Remove the chimney from the designer hood.
- Unscrew the two (2) screws on top of the cover.
- Slowly pull up the cover and put a side.
- Screw the charcoal filter on the motor.
- Install back the cover and chimney hood.

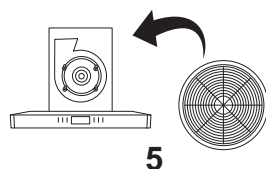

6

NOTES FOR THE INSTALLER

SAFETY INFORMATION

- Power connections must be made only in accordance to the local standards and laws.
- Ensure that the power supply complies with the setting on this appliance, otherwise, do not connect.
- The power connection of this appliance must be earthed. If unsure, check with a qualified electrician. The colour codes are:
 - Green & Yellow = EARTH
 - Blue = NEUTRAL
 - Brown = LIVE
- Ensure that the power cord is not exposed to heat sources or sharp objects.
- LED lamp must not exceed 1.5W.

TROUBLESHOOTING

PROBLEM	CAUSE	SOLUTION
No operation	No electrical supply	Ensure that power switch is turned on
		Ensure power plug is connected to the power supply
Poor airflow	Aluminium grease filters are clogged.	Clean the filters and replace when dry
	Charcoal grease filters are clogged	Replace charcoal filters
Motor running but no airflow	Butterfly valve jammed	Contact technician
Motor cuts after a few minutes	High temperature safety device activated	The kitchen is not sufficiently ventilated
	The hood is installed too near the cooking stove	Ensure the hood is installed at least 65cm from the stove
Strong cooking smell	Charcoal filters are not installed	Charcoal filters must be installed in re-circulating mode
Oil dripping onto stove	Oil cup missing or not installed	Remove aluminium filter and replace oil cup
	Aluminium grease filter saturated	Wash the aluminium grease filters
Whirring sound	Foreign object in contact with fan blade	Contact technician

7