

 **Mórgan®**

USER MANUAL

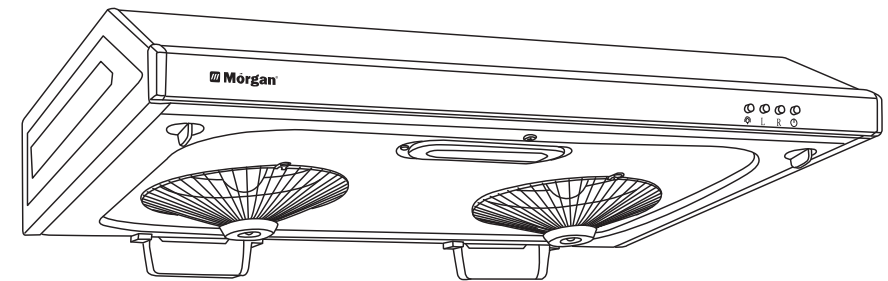

 **Mórgan®**

Market Expansion
Services by
www.dksh.com.my



E-mail: electrical.appliance@dksh.com
www.morgan.my

 facebook.com/morganappliances

Range Hood

MCH-NC276(DM)

C O N T E N T S

3 Pre-Installation Instructions

4 Parts And Features

5 Instruction Steps

5 Cleaning Instructions

6 Safety Precautions

6 Troubleshooting

7 Specifications

PRE-INSTALLATION INSTRUCTIONS

PLEASE CONFIRM THE FOLLOWING BEFORE INSTALLATION:

A) ENVIRONMENT:

Keep the Range Hood away from the window to ensure the effectiveness of the unit's suction power.

B) INSTALLATION HEIGHT:

The installation height is measured from the button of the Range Hood to the top of the stove; the recommended height is 28" – 30".

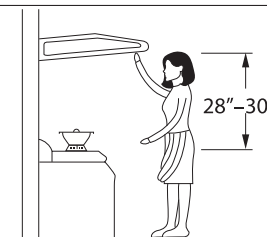

C) OIL COLLECTION:

The cooker hood must be incline upwards by 3°– 5° to facilitate the flow of oil into oil collection cap.

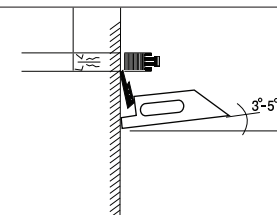

D) KEEP THE HOOD IN LEVEL:

Ensure the hood is in level when installing, as the inclination of the Range Hood will affect the spillage of waste.

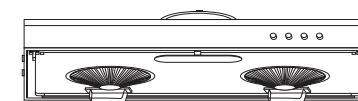

NOTE:

Please consult your authorised service technician or similarly qualified personnel should you encounter any problems with the Range Hood.

The manufacturer cannot be held liable for damage caused by non-compliance with these Warning and Safety instructions. Use this unit only in the manner intended by the manufacturer.

Always use genuine spare parts. Repairs or modifications undertaken by unqualified personnel can cause malfunctions or may damage the appliance, putting your safety in danger. If you have any questions, please contact the distributor.

PARTS AND FEATURES

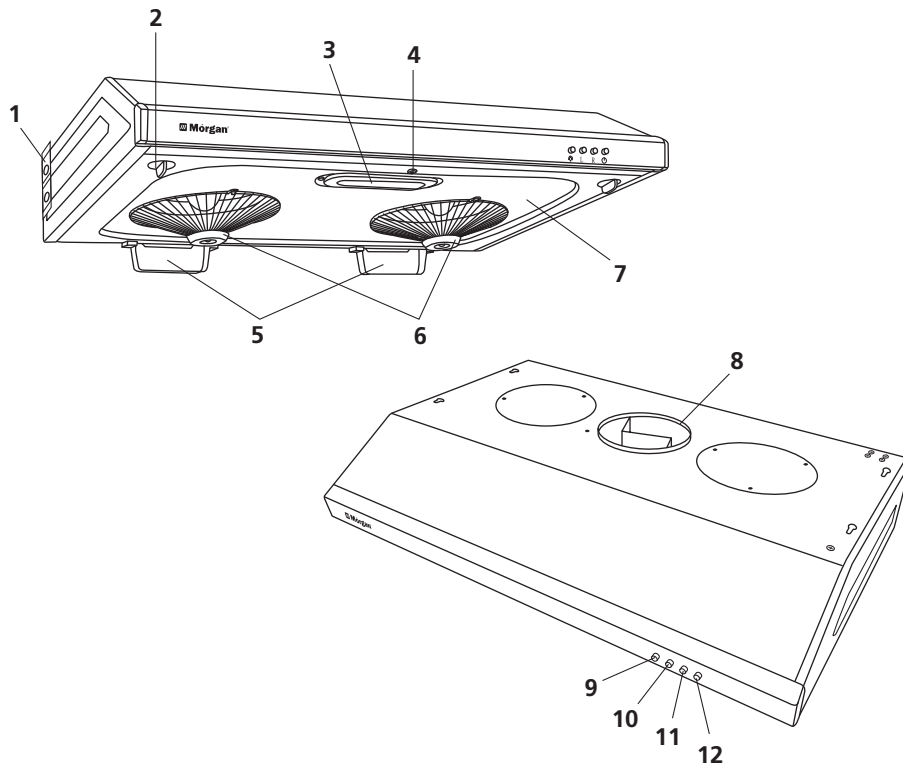

1. Mounting hooks with 2 screws(provided)
2. Cover release button
3. Power lamp
4. Cover Screws
5. Oil Cap
6. Safety Net
7. Cover
8. Activated Charcoal Filter
9. Light Switch
10. Speed Switch (Left) below motor
11. Speed switch (Right) below motor
12. ON/OFF Switch

INSTALLATION STEPS

- A. Gently release the bolt of the hanging iron (do not release the bolt completely). Slide the hanging iron upwards completely. Fasten the bolt tightly.
- B. Determine the height. Let the “U” shop hole of the hanging iron match the position on the round hole. Fasten 1/4” depth of the hole. Insert the plastic plug in the hole.
- C. Fix the installation screw on the most outer holes.
- D. Hang the “U” shop hole of the hanging iron on the installation screws. Fasten the installation screws tightly.
- E. Fasten the installation screws on the round hole.
- F. Insert the plug into the electrical socket.

CLEANING INSTRUCTIONS

- A. Remove the plug from the electrical socket.
- B. Loosen the casing cover screws.
- C. Push the cover release button towards the centre and remove the casing cover. Proceed with cleaning.
- D. Spray mild cleanser or use dishwashing liquid for everyday cleaning on the surface of the Range Hood.
- E. Clean the interior of the Range Hood every month using mild cleanser or dishwashing liquid soaked in warm water.
- F. Use a soft cleaning brush when cleaning the inner parts of the Range Hood. Please exercise caution during cleaning and we recommend you to wear gloves.
- G. Do not use steel brush or steel wool to remove stubborn dirt.
- H. Avoid using abrasive cleansers.

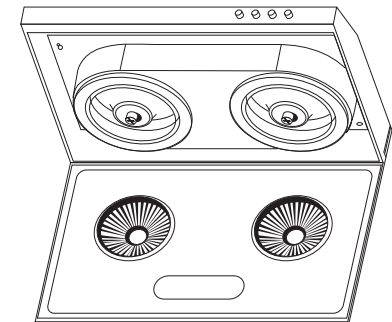
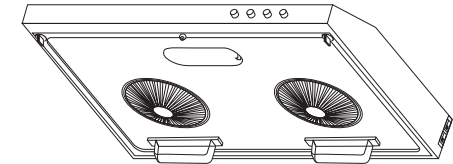

SAFETY PRECAUTIONS

- A. The exhaust pipe must be ducted outdoors.
- B. Ensure adequate ventilation in the area where the Range Hood is used.
- C. Ensure that Range Hood duct is extracted to an individual exhaust only.
- D. **WARNING: Do not expose naked flame direct under the hood.**
- E. There is a risk if cleaning is not carried out in accordance with the instructions.

TROUBLESHOOTING

REASON OF BREAKDOWN	SOLUTIONS
No electric power	<p>Check the plug and the socket</p> <p>Check the wires.</p>
The bulb does not light	<p>Check whether the bulb has burnt out</p> <p>Check whether the switch is damaged</p>
The motor does not rotate	<p>Check whether the switch of the motor is damaged</p> <p>Replace the motor if the switch is not damaged</p>
The Range Hood vibrates	<p>Check whether the blower is damaged.</p> <p>Replace the damaged blower.</p>

SPECIFICATIONS

Model	MCH-NC276(DM)
Dimension (mm)	825W X 580D X 215H
Elec. Specification	220-240V~ 50/60Hz
Dimension Outlet Pipe	Ø 6"
Transmission Style	Twin Motor
Lighting	25W
Extraction Capacity	900m ³ /hr
Speed Ranges	1300R.P.M
Net Weight.	10.5kg
Gross Weight.	11.5kg
Noise	≤ 56dB
Colour	Mocha