

 **Mórgan®**

 **Mórgan®**

Market Expansion
Services by
www.dksh.com



DKSH

E-mail: electrical.appliance@dksh.com
www.morgan.my

USER MANUAL

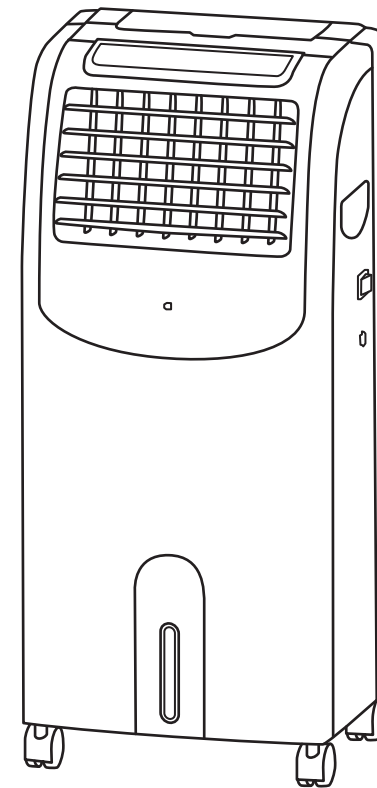

Air Cooler

MAC-COOL2

MAINTENANCE AND CLEANING

Note: After prolonged use, the filtration mesh will naturally become clogged with dust and dirt. This will affect the unit's performance and as such, it is recommended to clean the filtration mesh frequently.

CLEANING THE FILTRATION MESH

1. Remove power plug from the power supply.
2. Grasp the filtration mesh handle and pull upwards (*fig. 4*)
3. Clean filtration mesh using mild detergent and soft brush.
4. Ensure filtration mesh is thoroughly dry before installing.

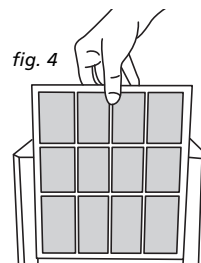

CLEANING THE WATER TANK

1. Remove power plug from the power supply.
2. Detach the water tank from the unit (*fig. 5*)
3. Clean the water tank with a little mild detergent on a towel and then rinse in water.
4. Attach the water tank in place after cleaning.

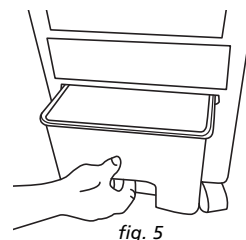

CLEANING THE BODY

Clean the body using mild detergent and a soft cloth.

IMPORTANT

- Unplug from power supply before cleaning
- Ensure there is no water on the control panel.

C O N T E N T S

4 Product Features

4 Construction Drawing

5 Accessories List

5 Specifications

5-7 Operating Instruction

8-9 Important Safeguards

10 Maintenance and Cleaning

11 Troubleshooting

IMPORTANT SAFEGUARDS

1. READ ALL INSTRUCTIONS CAREFULLY BEFORE USING.
2. Do NOT open and repair the unit by yourself or any unqualified person.
3. To protect against electric shocks, keep the unit dry. Do not immerse in water or any other liquids.
4. Unplug from power supply when filling water, before cleaning, maintenance works or moving the unit.
5. Unplug from power supply when not in use.
6. Do not insert foreign objects into the air vent grids (intake or outlet) during operation.
7. Do not cover the appliance with paper, cardboard, plastic metal foil, or any other flammable materials as, a fire may occur. Keep the appliance away from any heat sources.
8. Place the unit on a solid hot-proof horizontal surface.
9. Do not use outdoor.
10. Water level must be between the MIN and MAX line.
11. After filling with water, do not tilt the unit and avoid moving it as this may cause water to overflow from the side of the tank and leak. If the unit needs to be moved a little, push on the side gently.
12. Never turn the unit on its sides.
13. Do not place any objects on top of the unit. The air vent must not be obstructed during operation.
14. Do not use petrol or any petroleum-based solvents to clean the body. For slight dirt on the body, wipe it off with a soft damp cloth. To remove grease, squeeze a little toothpaste or mild detergent onto a soft damp cloth, and then wipe the dirt off.
15. Keep the air vent (intake or outlet) away from obstacles.
16. Do not strike or shake the unit body during operation, otherwise, it will cease operation automatically. Should this happen, restart the unit.
17. Due to prolonged use, dust and dirt will accumulate inside the water tank. It is recommended to change the water and clean water tank frequently. If the humidifier function is selected when the room temperature is below 0°C, be sure to add warm water into the water tank.
18. Empty water tank to avoid unpleasant odours from occurring when not in use.
19. Do not use after the unit malfunctions. Send to an authorized service centre immediately for repairs.
20. Do not use the unit for other than its intended use.

ACCESSORIES LIST

SEQUENCE	ACCESSORY NAME	QUANTITY (pcs)
1	Remote Control	1
2	Instruction Manual	1
3	Caster with skid lock	2
4	Caster without skid lock	2
5	Caster wrench	1

SPECIFICATIONS

MODEL	MAC-COOL2
RATING VOLTAGE / FREQUENCY	220-240V~ 50Hz
RATED WATTAGE	80W
MAX AIR FLOW	1130m ³ /h
MAX WATER VOLUME	7L
NET WEIGHT	7.5Kg
MEASUREMENTS(mm)	380 X 318 X 805
Note: Due to continuous improvement to our products, we reserve the right to modify and upgrade the specification and design without prior notice.	

OPERATING INSTRUCTIONS

1. Remove the unit from the carton and place it on a solid heat-proof horizontal surface.
2. Ensure the accessories are complete, corresponding to the accessories list.
3. Place the unit on a solid heat-proof horizontal surface. Assemble the casters using the caster wrench.

Note: Casters with skid lock fit into the two front holes whilst casters without skid lock are meant for the two back holes at the bottom of the unit.

(Shown as fig. 1)

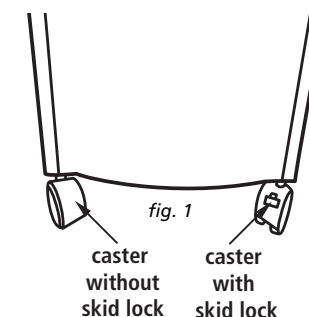

OPERATING INSTRUCTIONS

4. Remove the water tank and pull outwards about 10cm to align to the locking pin, then add water. (shown as fig. 2)

NOTE:

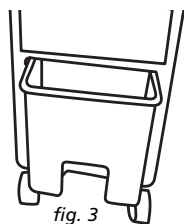

- a) Water level must be between the MIN and MAX line. (Shown as fig. 3)
- b) Due to prolonged use, dust and dirt may accumulate in the water tank. It is recommended to change water and clean the water tank frequently.

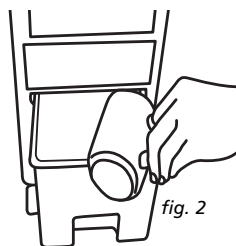

5. Only use the unit with the recommended AC outlet.
6. Insert the power plug pin into a power supply and turn on the power switch located at the side of the unit. Once switched on, a soft beep sound can be heard and the power indicator will be lit.

NOTE:

- a) To protect against electric shocks, do not remove power plug from power supply with wet hands.
- b) Unplug from power supply while moving the unit.
- c) Insert the power plug pin into the power supply and ensure it is properly connected.
7. Press "HUMIDIFY" button to dehumidify the air and to prevent skin dry .

CONTROL PANEL

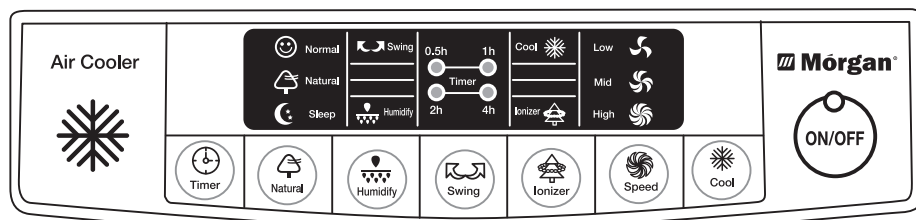

1. ON/OFF

- Press this button once to operate the unit. It will begin at MID for 3 seconds and then revert to work under the memorized status. For first time use, it will begin at MID for 3 seconds and then resume to LOW.
- Press this button again to turn the unit off.

OPERATING INSTRUCTIONS

2. SPEED

- Press this button to select desired fan speeds – LOW / MID / HIGH / LOW respectively. The corresponding air flow speed will be displayed.

3. WIND

- Press this button to select desired wind modes, NATURE/SLEEP/NORMAL/NATURE respectively. The corresponding air flow speed will be displayed.
 - NORMAL: It works as per the selected fan speeds (HIGH, MID, LOW)
 - NATURE: It works as per the preset program, – natural wind
 - SLEEP: It works as per the preset program, alternating between different fan speeds.
 - If HIGH is selected, the unit will operate under HIGH NATURE wind mode for half an hour, then revert to MID NATURE wind modes for half an hour before resuming to LOW NATURE wind mode.
 - If MID is selected, the unit will operate under MID NATURE wind mode for half an hour before reverting to LOW NATURE wind mode.
 - If LOW is selected, the unit will operate under LOW NATURE wind mode.

4. SWING

- Press this button once to horizontally swing the vertical louvers. The SWING indicator symbol will be displayed. Press again to fix air direction. To direct vertical airflow, adjust the horizontal louvers manually.

5. HUMIDIFIER

- During operation, press this button to humidify the air, improve air quality, and prevent dry skin. Press this button again to cancel.

6. COOL

- Press this button once to start the evaporative cooling function. Press this button again to cancel.

7. IONIZER

- Press this button once to release negative ions into the air, to refresh and ionize the air. Press this button again to cancel.

8. TIMER

- It can be set between 0.5 to 7.5 hours, increased at 0.5 hours intervals. It is set to 7.5 hours when all of the 4 timer indicators are switched on. Press this button again to cancel.

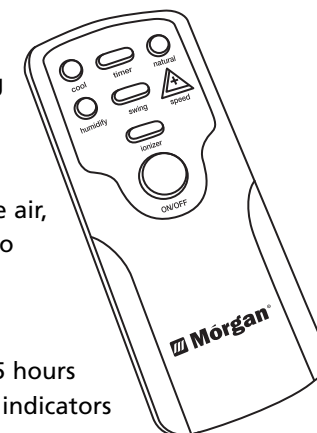

Thank you for purchasing Morgan Air Cooler. Please read all instructions carefully before using it for the first time. Always keep this manual for future reference.

PRODUCT FEATURES

- Cool – cycles the water to blow cool air and lowers the surrounding temperature to provide a cool, comfortable environment.
- Humidifier –humidifies the air to prevent dry skin.
- Ionizer –releases negative ions to refresh the air and for health.
- Easy to clean drawer style water tank, detachable filtration mesh – the filter removes harmful solid but tiny substances, such as dust and pollen.
- Energy saving, high-efficiency, environment friendly with 80W input power.
- Choice of Air output – 100 angle wide ranges. 3 fan speeds; HI-MID-LOW.
- Memory function –memorizes current operation status that remains in use until power is switched off.
- High tech computerized control system.
- 0.5 – 7.5 hours timer setting.

CONSTRUCTION DRAWING

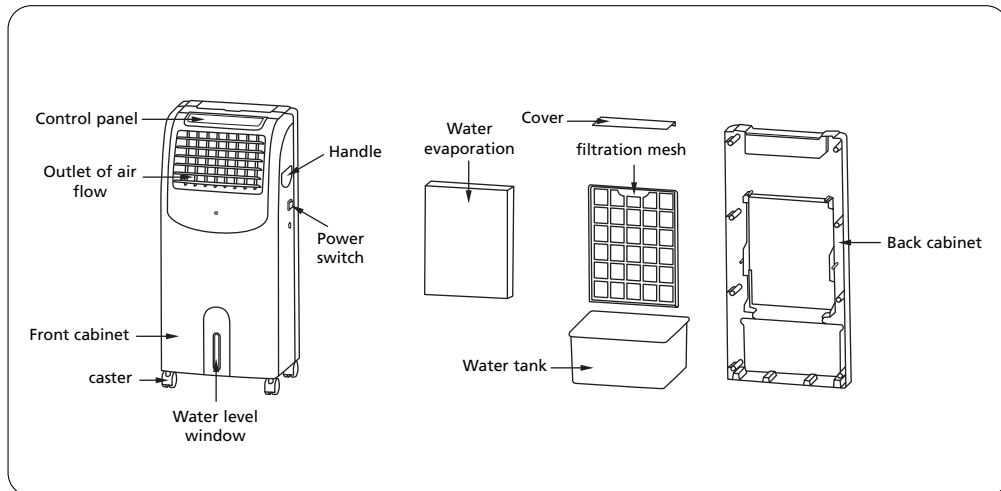

IMPORTANT SAFEGUARDS

21. Do not use the unit with the power cord damaged. Send to an authorized service centre for repairs immediately. If the power supply cord damaged, it must be replaced by a recommended power cord or assembly available from the manufacturer or its service agent.
22. Keep the unit out of reach of children. Close supervision should be exercised when children are nearby.

WARNING: Please do not use the unit where children can easily come into contact with nor allow children to operate the unit themselves.
23. Keep power cord away from sharp or hot objects.
24. Thoroughly clean the unit before using it for the first time.
25. Do not clean with metal scouring pads. It may scratch the surface or cause electrical shock.
26. Do not clean the unit with flammable liquids.
27. Avoid sharing a power outlet with other appliances.
28. Always attach the power plug to the appliance first, only then plug the power cord into the power supply. To disconnect, turn all controls to 'OFF' position before removing the power plug from the wall outlet.
29. Do not combine the use of new and old batteries at the same time inside the remote control.
30. Remove batteries from the remote control when not in use.

TROUBLESHOOTING

In most cases, any problem encountered during operation may not be attributed with the malfunction of the unit. The following are checklist to follow before sending the unit for repair.

Problem	Possible Reasons	Solutions
Unit not functioning	The power plug is not properly inserted into the power socket or not well connected.	Insert the power plug pin into the power supply and ensure it is properly connected.
	The "I" button, located on the power switch which is at the side of the unit body has not been activated.	Press the "I" button, on the power switch located at the side of the unit's body.
	The "ON/OFF" button is not activated.	Press "ON/OFF" button after connecting the power plug to the power supply.
Dust filtration function not working efficiently	The filtration mesh is clogged with dust and dirt, affecting the unit's performance	Clean the filtration mesh.
	The air vent is obstructed	Remove any foreign objects from the air vent.

IMPORTANT:

- 1. If the problem encountered is not listed above, please contact our service centre or a qualified technician for further inspection.**
- 2. Do NOT attempt to disassemble and repair the unit yourself.**