

Mórgan®

USER MANUAL

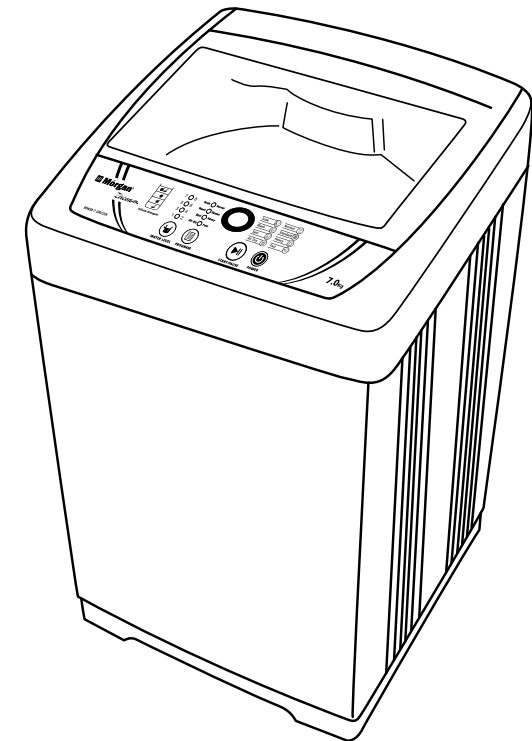

Automatic Washing Machine

MWM-7 Zircon

Mórgan®

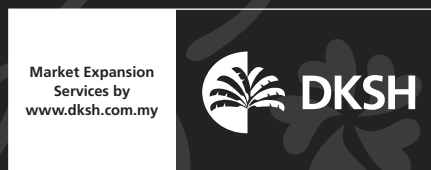

E-mail: electrical.appliance@dksh.com
www.morgan.my

 facebook.com/morganappliances

C O N T E N T S

- 3** PARTS IDENTIFICATION
- 4** SAFETY AND PRECAUTIONS
- 6** INSTALLATION & ADJUSTMENT
- 6** USING THE DRAIN HOSE
- 8** WATER INLET INSTALLATION
- 10** PREPARATION BEFORE OPERATION
- 11** LOADING LAUNDRY
- 12** DETERGENT GUIDE
- 13** CONTROL PANEL & FEATURES
- 14** OPERATING INSTRUCTIONS
- 15** CARE & CLEANING
- 16** TROUBLESHOOTING
- 17** OTHER FUNCTION
- 18** SPECIFICATIONS

PARTS IDENTIFICATION

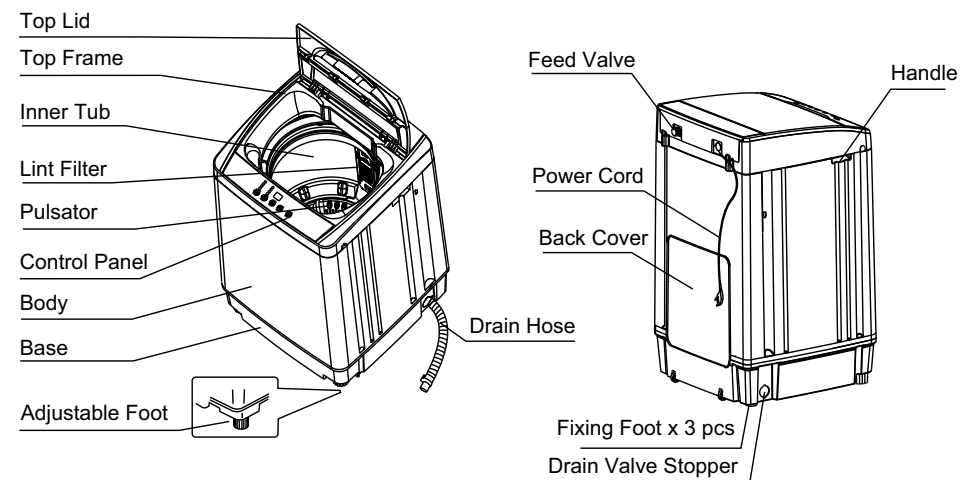

ACCESSORIES

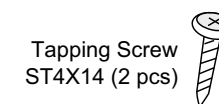
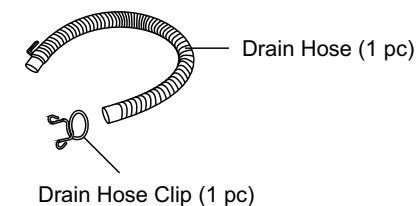
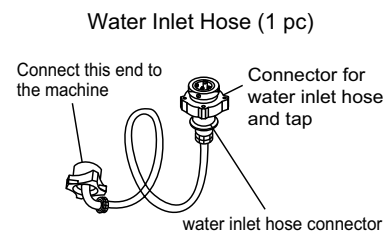

ABOUT THE SAFETY SYMBOLS



WARNING SYMBOL

Pay special attention to the warning symbols. There may be serious risks to personal body safety or damage to the appliance if warnings are not followed.



PROHIBITION SYMBOL

This symbol strictly prohibits action(s) that may be dangerous to your personal safety and/or may damage the appliance.

SAFETY PRECAUTIONS

Insert power plug into an earthed rated 220-240V AC power supply.

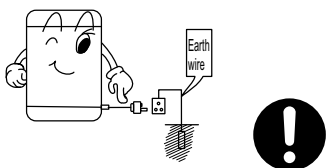

Always unplug from power supply & turn off water when not in use, or when cleaning or moving the appliance. Do not touch power plug with wet hands.

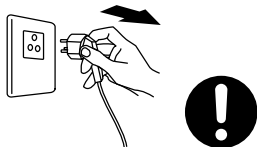

Do not bend or twist the power cord in any manner. Do not operate appliance with damaged power cord or power plug or after the appliance malfunctions. Contact your Authorized Service Centre for examination, repair, or adjustment. Ensure the pin of the power plug is clean & wipe with cloth if dirty.



- Do not install the appliance in the bathroom or damp places.
- Do not splash water on it or place wet clothes on the control panel.

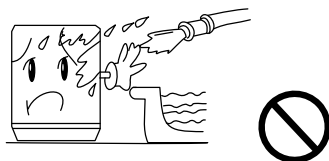

Do not wash with water hotter than 50°C.



If placed on carpeted floor, adjust the fixing feet to allow air to flow freely.

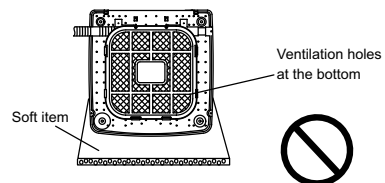

Do not wash raincoat, motorcycle cover, feather dress or waterproof apparels as these may cause the appliance to vibrate abnormally during operation.



- Do not share the same power socket or use an extension socket.
- Do not use a damaged or loose power socket.

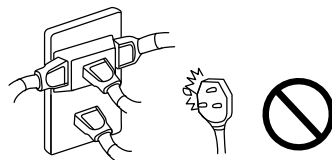

SAFETY PRECAUTIONS

- Do not insert hands into the machine during operation, even during slow speeds.
- Never allow children to play on or near the machine during operation.

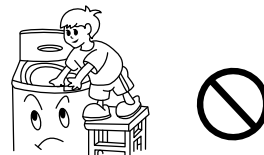

It is dangerous to alter the specifications or modify this appliance in any manner.

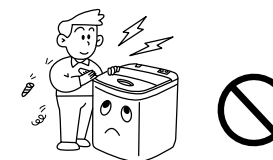

Do not overload the appliance or place any hot items such as hot kettle on the washing machine.



Do not wash garments which have been in contact with volatile petroleum products.



- Do not leave children unattended near the washing machine.
- Do not allow children to play with the washing machine.



Keep the appliance away from direct sunlight and other heat sources which may damage it.

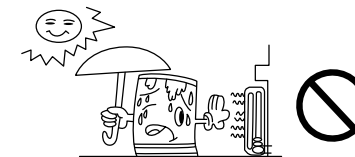

Always clean the lint filter to prevent lint from obstructing the cascade outlet during washing. Ensure proper installation after every clean.

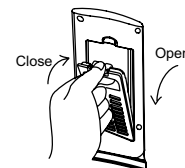

Do not place hard objects such as coins, safety pins, nails, screws, or which can damage the machine.

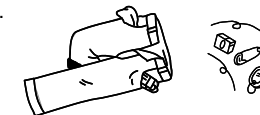

- Ensure water tap is turned on and inlet hose is properly installed before washing.
- It is recommended to use low suds & high efficiency laundry detergent.

INSTALLATION & ADJUSTMENT

It is important to install and adjust the machine according to the requirements of the manual for your safety and correct operation

UNPACKING

- Unpack the carton and retrieve the bottom panel.
- Open the top lid of the machine and remove all accessories. Remove all wrappers, including the polystyrene base.
- It is recommended to keep the packaging for reuse in case the machine is to be transported again.

INSTALLING THE BOTTOM COVER

- Lean the machine forward gently and insert the bottom cover (the side with instructions) into the notch along arrowhead direction.
- Fix the bottom cover on the washing machine base with two tapping screws in the provided accessories by using a cross screwdriver.

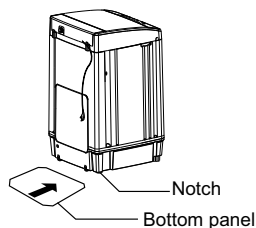

POSITIONING

The distance between the washing machine and the wall should preferably exceed 50mm, and the maximum allowed angle of the shank base of the machine is 1°. Slanting or uneven ground may cause operation to stop. It is recommended to adjust with the following methods:

Make it horizontal

Use a tied thread with plumb to ensure it is horizontal.

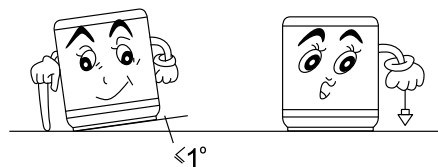

Adjust the adjustable feet

- Lift the adjustable foot gently, loosen the adjustable nut and twist the adjustable foot.
- Fasten the nut after adjustment.

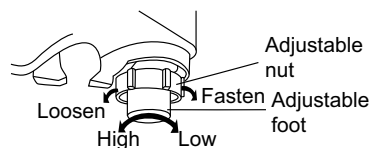

USING THE DRAIN HOSE

INSTALLING THE DRAIN HOSE

- Set the drain hose clip into the drain hose to 2-3cm (from the end of the drain hose without the pot hook).
- Install the drain hose into the correct drain hose connector and fix the drain hose connector with the clip.
- Attach drain hose clip on the machine cabinet.

USING THE DRAIN HOSE

CHANGING THE DIRECTION OF THE DRAIN HOSE

1. Detach the drain hose and clip from the connector. Place the machine front side down on a soft mat on the floor. Unmount the screws on the back cover using a screwdriver and detach the back cover. Unmount the screw fixed to the drain hose connector (on the right of washing machine) and loosen the drain hose connector.
2. Detach the drain hose using reasonable force and drain hose hoop (on the right of washing machine). Loosen the inner drain hose.
3. Detach the drain hose gate stopper (left side of the machine fixed on washing machine base with two clips).
4. Place the inner drain hose to another side. Do not distort the inner drain hose. Fix inner drain hose with drain hose hoop and drain hose connector. Stand the washing machine gently and secure the back cover with screw and install the drain hose and clip into the drain hose connector.

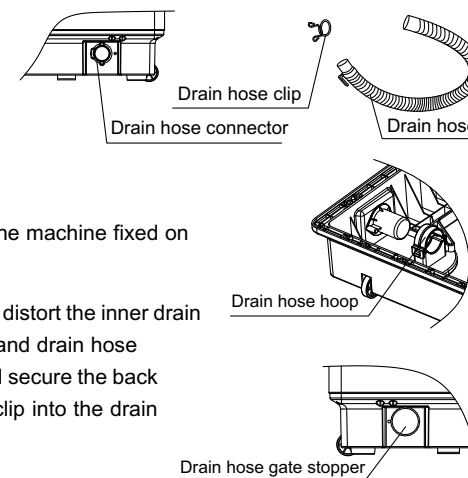

WATER DRAINAGE

To ensure the drain hose drains smoothly:

1. The height of the drain hose should be less than 10cm to ensure proper drainage.
2. Do not step on or distort the drain hose.
3. Cut the drain hose if it is too long. Cut the front end of the drain hose slant to ensure drainage is smooth.
4. Purchase a longer hose for longer drainage with diameter not less than 30mm and length not exceeding 1.5m.
5. Cut at Points A or B if the additional drain hose is too long.

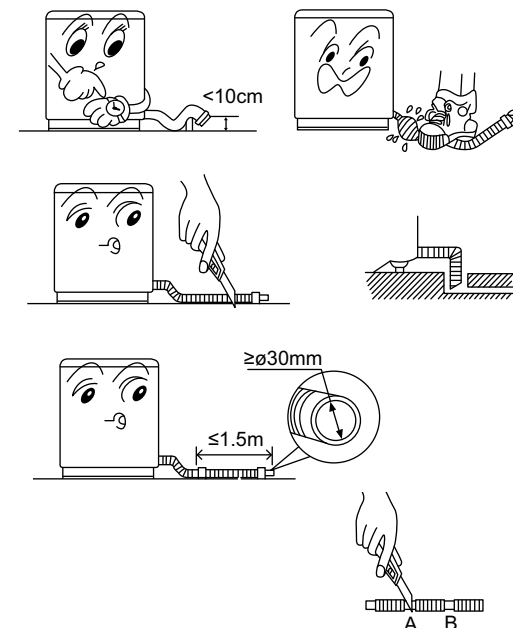

WATER INLET INSTALLATION

TAP SELECTION

Recommended Tap

Not recommended tap

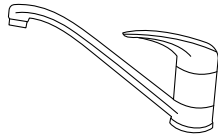
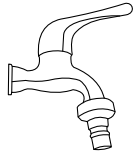

Ensure front end is longer than 10mm & tap exit end face is flat and smooth to avoid leakage.

CONNECTING THE INLET HOSE CONNECTOR WITH THE WATER TAP

1. Press the lower end of the lock lever and push down the slider. Remove inlet hose connector from the inlet hose (see illustration 1).
2. Loosen the four bolts on the inlet hose connector to access the tap. Then set the inlet hose connector to the tap (see illustration 2)

Note: If tap calliper is unable to fit into the inlet hose end, unscrew the four bolts and remove the bushing.

Important: Tap exit end must be flat otherwise it will leak (see illustration 3).

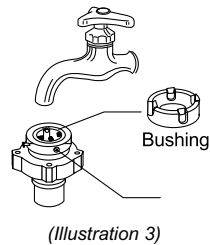
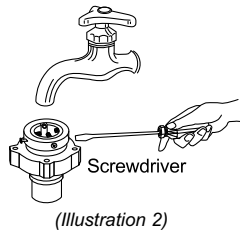
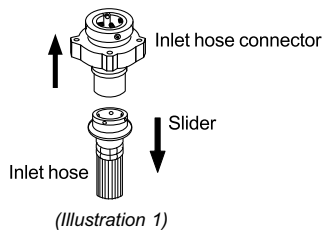

3. Fasten the four bolts in the inlet hose connector evenly (see illustration 4).
4. Turn the fastening nut (see illustration 5).

Note: Before turning the fastening nut, ensure threading is about 4mm above the upper surface of the nut and less than 2mm above the upper surface of the nut after securing (see illustration 6).

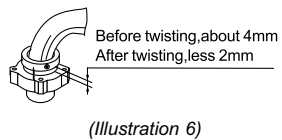
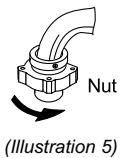
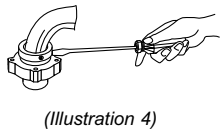

WATER INLET INSTALLATION

CONNECTING INLET HOSE TO THE WASHING MACHINE

1. Do not remove the water absorption cushion.
2. Inspect if water absorption cushion is dropped or damaged before every operation.
3. If it is, contact your authorized service agent immediately.
4. Attach the inlet hose nut on the inlet valve connector.
5. Fasten the inlet hose nut and swing it gently to make secure the connection.

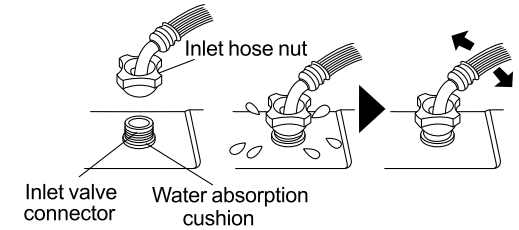

CONNECTING INLET HOSE CONNECTOR WITH THE INLET HOSE

1. Push down the slider & insert the inlet hose into the connector.
2. Hang the lock lever to the inlet hose connector and release the slider until a click sound is heard.

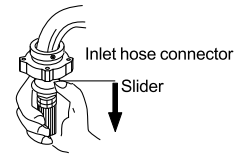

CHECK CONNECTION BETWEEN INLET HOSE CONNECTOR & TAP

1. Swing the inlet hose gently to ensure it is fastened & secure.
2. After installation, turn on tap to inspect for leaks.
3. Do not bend/twist or distort the inlet hose.
4. Inspect proper connection between inlet hose connector and the tap before every operation.
5. Ensure they are secure to prevent & not loose.

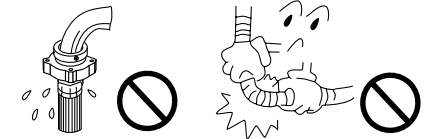

DISMANTLING INLET HOSE

1. Turn off the tap.
2. Press the locking lever, push down slider & detach inlet hose.
3. Leave inlet hose connected to the tap if machine is used frequently to prevent damaging the fixing screws.

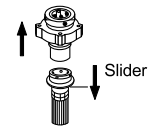

PREPARATION BEFORE OPERATION

PREPARATION BEFORE WASHING

1. Connect the inlet hose and turn on the tap.
2. This appliance must be properly earthed before connecting to the power supply. Do not link the earth terminal gas or tap pipeline, and so forth.
3. Lay down the drain hose.

Warning: Water temperature should not exceed 50°C!

IT IS IMPORTANT TO NOTE THE FOLLOWING BEFORE LAUNDRYING:

Check whether there are special requirements for laundering.	Ensure all pockets are empty of small objects such as coins, keys, screws etc. as these may damage the drain pump.	Knot long bands, fasten buttons and zippers.	Do not overload machine. Load laundry loosely alternating larger items with smaller ones.	Sort laundry according to fabric type, colourfastness, and soil level. Place thin fabric, woollens and those prone to wear and tear into laundry bag.
--	--	--	---	---

- Ensure laundry is washable.
- **IMPORTANT:** Wash new coloured clothing separately when washing for the first time and do not wash white clothing with coloured ones.
- Immerse non-absorbable laundry by hand.
- Treat stubborn stains such as fruit, wine, grass, rust etc. with specially formulated pre-wash detergent before laundering.
- Overturn the nap fabric and long floss laundry before putting them into the machine.
- Do not place chemical-soaked laundry directly into the machine.
- Place small items such as handkerchiefs, ribbons, socks etc. into laundry bag or pillow case.

LOADING LAUNDRY

- The machine's washing and spinning capacity refer to the largest weight of standard laundry under dry condition. Washing quantity shall be lower than the rated capacity.
- Different thickness, size and laundry type will influence the actual washing capacity. It is ideal that laundry can be overturned normally during washing.
- Do not select high water level when laundry is less than 1.0kg to avoid water splashing.



LAUNDRY REFERENCE GUIDE

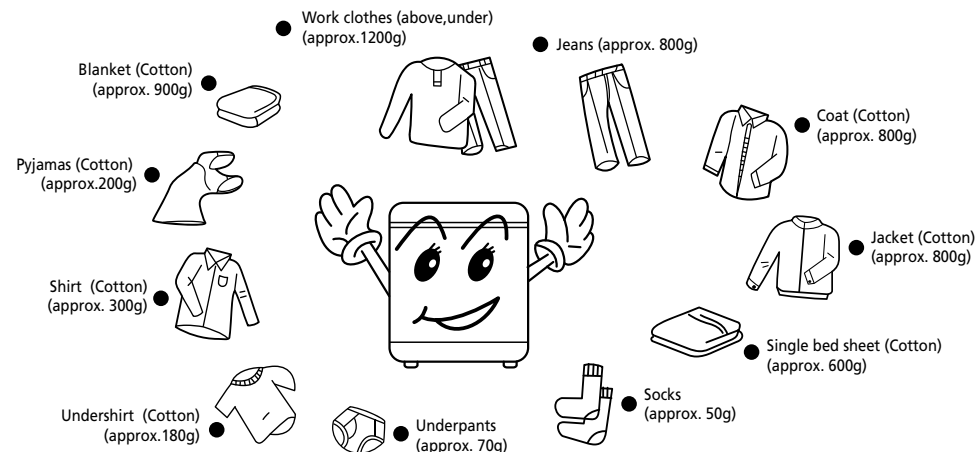

DETERGENT GUIDE

- Pour powdered detergent into the tub (see figure below).
- Close the top lid.
- It is recommended to use low suds, high-efficiency powdered detergent.

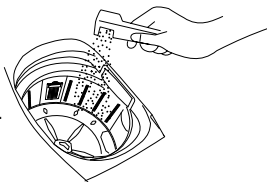

USING POWDERED DETERGENT

Dissolve powdered detergent directly in machine (not suitable for delay program):

- Select Low water level.
- Add powdered detergent and run for 30 seconds to dissolve it completely.
- Place laundry & select suitable water level program.

Dissolve powdered detergent prior to washing:

- Prepare warm water (30 °C) in a container.
- Pour powdered detergent while stirring to fully dissolve it.
- Do not use too much powdered detergent as it may discolour clothes and not rinse out completely.
- Inferior quality powdered detergent may cake if not used for some time.
- It is recommended to clean the detergent drawer frequently for best washing results.

USING BLEACH

- Fill water to the selected level, dilute the bleach in the container.
- Slowly pour into the washing tub.
- Do not use bleach for coloured or fragile clothing to avoid damage.
- Do not pour bleach to directly onto laundry.
- Refer to the manual for the usage and quantity of the bleach. * Note: Always dissolve powdered bleach before use.

For the quantity of concentrated washing powder, please refer to your manual.

REMARKS:

- Do not use excessive powdered detergent.
- Do not select high water level for small laundry loads.

CONTROL PANEL & FEATURES

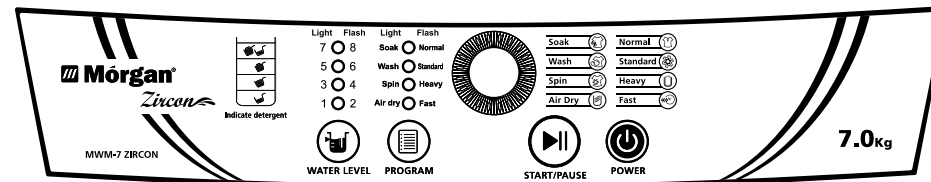

MODE & INDICATOR LIGHTS

ON: indicate selected mode

FLASHING: indicate the program is running

- On startup, press 'Water Level' to select water level according to laundry load.
 - 1-2 is low water level
 - 3-5 is middle water level
 - 6-8 is high water level
- When water level is set with '1,3,5 or 7', the light will always illuminate.
- When water level is set with '2,4, 6 or 8', the light will flash.

To add water during washing/rinse:

- Press 'Water Level' button to add water
- Release 'Water Level' button to stop.
- Pause operation & press 'Water Level' button to select higher water level.
- Press Start/Pause button to add water automatically and continue operation.
- If selected water level is lower than existing water level, the same water level will automatically apply for the next cycle.

8 PROGRAM SELECTION:

'Normal', 'Standard', 'Heavy', 'Fast', 'Soak', 'Wash', 'Spin', 'Airdry'.

- When setting program 'soak, wash, spin or air dry', the light will always illuminate.
- When set program 'normal, standard, heavy or fast', the light will flash.

Note: Program setting on startup will always revert to 'Normal'.

POWERS: the machine ON or OFF.

- Press START button to begin washing operation after setting water level, program and process.
- Press again to PAUSE washing.

1. Press POWER button to power on machine.
2. Machine will be in standby mode.
3. Select desired water level according to laundry load.
4. Press "program" button to select desired program.
5. To select "Air Dry" at the beginning of operation, press "Program" button to select "Air dry".
The machine will be in standby mode when air dry function is completed.
6. Close the top lid, press START/PAUSE to begin operation.
7. The buzzer will sound & power will automatically cut-off after operation is completed.

AFTER EVERY WASH

- The machine stops automatically, and the buzzer will sound to remind you to remove the laundry or begin another wash.
- Always unplug machine from the power supply after every wash and turn off the water tap to prevent leaks.

EXTERIOR CARE & CLEANING

- Clean the machine exterior using a soft, damp cloth.
- Do not use abrasive cleansers or chemicals to avoid damaging plastic parts and surface.



CLEANING INLET GATE

The inlet gate filter may be obstructed by dust. To clean:

- Turn off water tap and turn on the power switch.
- Start machine for 5 seconds & allow water in the inlet hose flow into the tub.
- Turn off power.
- Detach inlet hose, remove and clean the inlet gate valve and the inlet gate filter.
- Reassemble the inlet gate & filter.

CLEAN LINT FILTER

It is recommended to clean the lint filter after every wash. To clean:

- Detach the lint filter (see Illustration 1).
- Open the lint filter and wash it (see Illustration 2).
- Close the lint filter and reassemble.

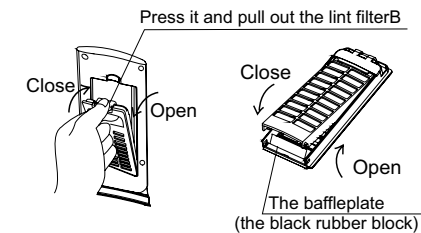

Illustration 1

Illustration 2

MAINTENANCE TIPS

It is advisable to turn off the water tap after every wash & detach the inlet hose, if necessary. After every wash:

- Drain any remaining water in the tub immediately.
- Unplug power cord from the power supply.
- Store power cord and drain hose.
- Wipe the water on machine exterior & surface with soft cloth.
- Keep top lid open for a while to help prevent mould and stagnant smells from forming inside the appliance.

- Use this troubleshooting guide for a list of possible solutions if the machine does not perform as expected or malfunctions.
- If a solution cannot be found or the problem persists, please contact your authorized service center.
- Do not, under any circumstance, dismantle or attempt to repair the machine yourself.

PROBLEM	POSSIBLE CAUSES	SOLUTION
No display on control panel	<ul style="list-style-type: none"> • Power Plug is not inserted correctly. • No power supply. • Power switch is not turned on. 	<ul style="list-style-type: none"> • Reinsert power plug correctly. • Inspect the power socket or change to another power socket. • Press power switch. • Check power supply
Water inlet hose leaking	<ul style="list-style-type: none"> • Inlet hose connector (connecting with the tap) is not secure. • Inlet hose and washing machine connector is loose. 	<ul style="list-style-type: none"> • Reinstall the inlet hose again. • Tighten the connector of the machine.
Machine does not drain	<ul style="list-style-type: none"> • Drain hose is not placed down on floor level. • Drain hose is bent/twisted or obstructed. 	<ul style="list-style-type: none"> • Lay down the drain hose to floor level. • Straighten or clean the drain hose.
No water supply	<ul style="list-style-type: none"> • Tap is not turned on. • Water inlet hose is obstructed. 	<ul style="list-style-type: none"> • Restart when water supply is resumed. • Turn on the tap. • Follow instructions "cleaning the water inlet filter".
Spin function stops and water supply resumes during spin program	<ul style="list-style-type: none"> • Excessive or insufficient laundry load. • Machine is not placed on stable surface. 	<ul style="list-style-type: none"> • The machine will adjust itself automatically.
Spin function not working even when spin button is selected	<ul style="list-style-type: none"> • Top lid is open when drain function begins or when is completed. 	<ul style="list-style-type: none"> • Close the top lid.
Intermittent spin during spin function	<ul style="list-style-type: none"> • Balance laundry load for best spin results. 	<ul style="list-style-type: none"> • This is normal.
Water flows from drain hose during first use	<ul style="list-style-type: none"> • Water remnant in the tub during factory quality check and test 	<ul style="list-style-type: none"> • This is normal.

1. WHEN ALARM GOES OFF

PROBLEM	POSSIBLE CAUSES	SOLUTION
Indicator water level light, wash, spin & other lights not on.	Water drainage not completed even after 5 minutes.	Open & close top lid to clear the alarm.
Indicator water level light, spin, & other lights not on.	Top lid opened during spin function.	Close top lid to clear the alarm.
Indicator water level light, spin, Air Dry & other lights not on	Spin function is not balanced.	Close top lid to clear the alarm.
Indicator water level light, wash & other lights not on	Water inflow does not reach desired level even after 5 minutes.	Open & close top lid to clear the alarm.
Indicator water level light, soak & other lights not on.	Water exceeds the overflow level.	Drain excess water until the water level reaches the ideal water level.
Water level indicator light & other lights not on.	Water level sensor malfunction.	Turn off the power supply and contact your authorized technicians.

2. IMBALANCE ADJUSTMENT

- During spinning, violent vibrations may happen if laundry is not placed equally in the tub. This machine has an automatic imbalance adjustment function. Once vibration exceeds beyond a specified level, the adjustment system will start automatically to adjust the imbalance.

3. POWER SUPPLY IS CUT OFF AUTOMATICALLY

- If START/PAUSE button is not pressed within 10 minutes after pressing the POWER button, power supply will cut off automatically.
- Power supply will cut off automatically after washing is completed.

SPECIFICATIONS

Model	MWM-7 Zircon
Rated Voltage / Frequency	220-240V~ 50Hz
Washing Power	325W
Spinning Power	250W
Capacity	7.0kg
Weight	Approx. 30kg
Dimension (mm)	520W x 530D x 878H