

 **Mórgan®**

USER MANUAL

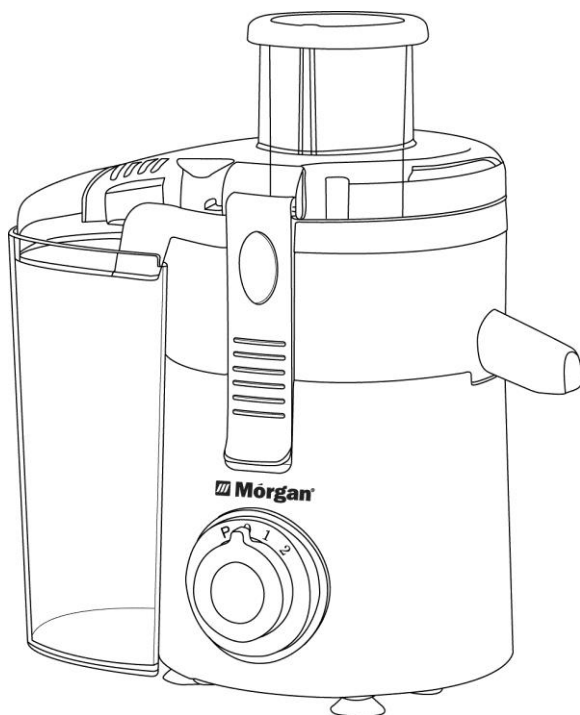

**Juice
Extractor**

MJE-AA05W

CONTENTS

1 Safety Precautions

2 Parts Identifications

2 Specifications

3 How to Assemble

5 How to Use Juice Extractor

6 Troubleshooting

8 Care and Cleaning

SAFETY PRECAUTIONS

When using the appliance, especially when children are present, basic safety precautions should always be followed including the following:

1. Read all instructions carefully before using the appliance.
2. Check that the voltage range given on the appliance-rating label corresponds with your main voltage.
3. This appliance is suitable for normal household use only and not for commercial use.
4. This product must not be left unattended while it is connected to the main supply.
5. Use the appliance only on a level working surface.
6. Do not hold the appliance on the slant while it is working.
7. Use only the push rod to push food into the head cover.
8. Never put your fingers in the head cover.
9. The juicer/blender has a built-in overheating protector that will turn off the power immediately when the motor is overheated or overloaded due to prolonged operation. If this happens, switch off power and allow unit to cool down (about 30 minutes) before resuming operation.
10. The use of attachments parts which not recommended may cause fire, electrical shock, or risk of injury.
11. Never open the cover before the motor has stopped. Never immerse the motor base in water; wipe with a damp cloth to clean it.
12. Unplug the unit when not in use and whenever you clean or move the unit.
13. To disconnect the appliance, set control to off, grip the plug and pull from wall outlet. Never yank on cord.
14. Repairs on electrical appliances or the supply cord, it must only be done by authorized service personnel. Faultily, unqualified repair work may cause accidents or injury to the user.
15. This appliance should not be used by people who are physically or mentally impaired (including children) unless proper guidance is provided during operation.

PARTS IDENTIFICATION

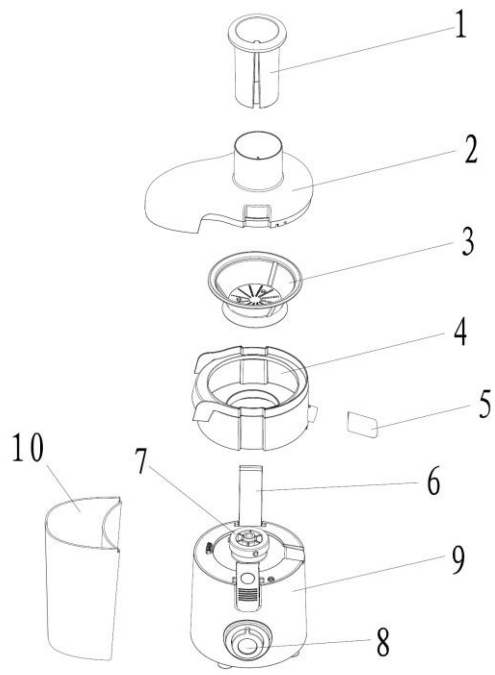

- 1) Push Rod
- 2) Head Cover
- 3) Juice Extraction Net
- 4) Central Ring
- 5) Juice Flowing Nozzle
- 6) Plate Buckle
- 7) Motor Wheel
- 8) Knob Switch
- 9) Body
- 10) Pomace Cup

SPECIFICATIONS

RATED VOLTAGE	220-240V~
RATED POWER	250W
FREQUENCY	50Hz

HOW TO ASSEMBLE

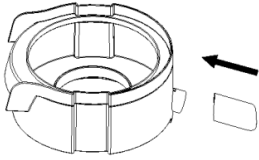

STEP 1

Align the juice flowing nozzle with the juice outlet of the central ring and install it.

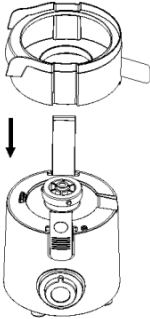

STEP 2

Place the central ring on the Body.

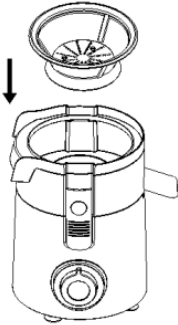

STEP 3

Put juice extraction net into the central ring and ensure it in the right place of the motor wheel. (Before using, please check if any damage on the net. If any, please stops using it and contact our customer service department nearby immediately).

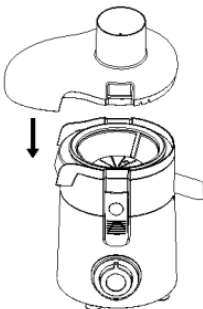

STEP 4

Install the head cover right above the body. Install it according to the picture given.

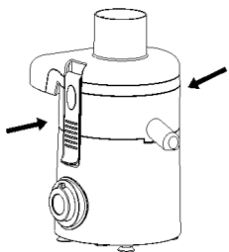

STEP 5

Button up the plate buckle with the double concave trough on the head cover, press down the buckle, and the sound of “click” means successful installation or it fails to work.

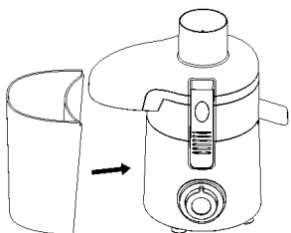

STEP 6

Install the pomace cup on to the body.

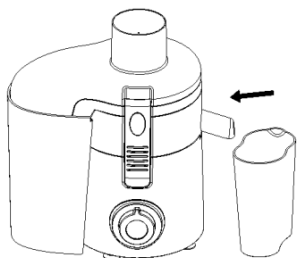

STEP 7

Place your own juice collecting cup under the juice flowing nozzle.

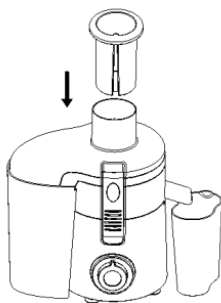

STEP 8

Align the trough of push rod with the direction inside the feed port on the head cover and push the rod into it.

HOW TO USE JUICE EXTRACTOR

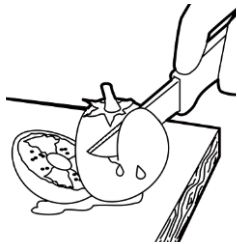

STEP 9

Wash fruits and vegetables, slice into pieces (with kernel, hard seeds, thick skin or hard shell shall be removed)

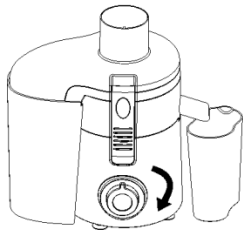

STEP 10

Start the switch; product starts working with working time less than 1 minute.

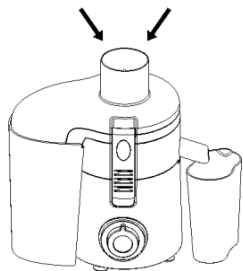

STEP 11

Feed fruits and vegetables prepared into the feed port.

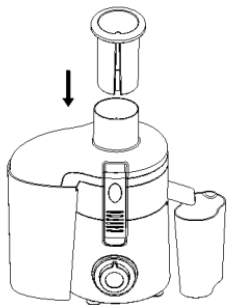

STEP 12

Push pieces of fruits and vegetables gently into the feed port with push rod. Too excessive of force implied on the rod may affect the juicing effect.

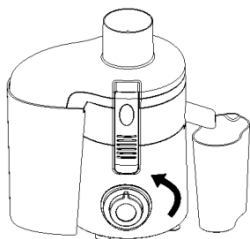

STEP 13

After completion of processing the ingredients, ensure no juice flowing from the nozzle. Switch off the power and remove the juice cup away from the nozzle after the motor stops.

Selection of fruits

1. Select fresh fruits and vegetables: containing much juice; suitable fruits: pineapple, beetroot, celery stick, apple, cucumber, melon, tomato, orange and grape etc.
2. Fruits and vegetables with thin skin are not required to peel but those with thick one such as orange, pineapple and raw beetroot. Citrus fruits' seeds, which may cause bitter taste to juice, shall be removed.
4. The freshly-extracted apple juice, which may turn to brown quickly, it can be added several drops of lemon juice to slow down discolor.
6. Fruits containing starch such as banana, papaya, avocado, figs and mango are not suitable to be put into this juice extractor to make juice.

TROUBLESHOOTING

Fault Phenomena	Cause Analysis	Troubleshooting
Unable to start switch or product fails to work.	<ol style="list-style-type: none">1. Improper installation of central ring.2. Head cover installed in wrong place.3. Motor thermal control protection	<ol style="list-style-type: none">1. Install central ring in proper place.2. Install head cover in place.3. Restart it after stopping 20-30 minutes.

For the first few time of use, the motor will give a bad burned smell.	It is normal	Send the product to our company's maintenance point nearby if the product gives off unpleasant smell event after repeated use.
Halting when in service.	<ol style="list-style-type: none"> 1. Under voltage 2. Excessive ingredients 3. Push the rod with excessive force 	<ol style="list-style-type: none"> 1. Check if under voltage 2. Disconnect power, take out the surplus ingredients. 3. Push the rod gently.
Much pomace contained in the juice	Juice extraction net damaged.	Replace the net.
Low quantity of juice	<ol style="list-style-type: none"> 1. Much pomace in the net. 2. Press the push rod with excessive force 	<ol style="list-style-type: none"> 1. Clean the net. 2. Press the push rod with proper
Abnormal vibration or big noise.	<ol style="list-style-type: none"> 1. Improper installation of juice extraction net and poor running balance. 2. Unstable placement of product or come off of foot pad. 3. Excessive ingredients 	<ol style="list-style-type: none"> 1. Install juice extraction net in proper place. 2. Place product stably or install the foot pad in proper place. 3. Disconnect power and take out surplus ingredients

CARE AND CLEANING

- 1) This juicer should be used often to ensure prolonged operation.
- 2) If the blender is not used for a long time, store it in a well-ventilated place to prevent the motor from dampness and going mouldy.
- 3) Do not immerse the motor housing into water or any other liquids. Wipe it with a dry cloth. Wash other parts with water and food-safe detergent.
- 4) Detach the juicer, blending and grinding blades. Lubricate them with a little vegetable oil to guarantee the smooth operation and performance of your juicer.
- 5) To clean the juicer - use warm water and several drops of food-safe detergent. Cover the cap, switch on the unit and let it run for 10 seconds. Alternatively, soak the juicer in water and clean it using a soft brush.



This marking indicates that this product should not be disposed with other household wastes throughout the nation. To prevent possible harm to the environment or human health from uncontrolled waste disposal, recycle it responsibly to promote the sustainable reuse of material resources. To return your used device, please use the return and collection systems or contact the retailer where the product was purchased. They can take this product for environmental safe recycling.

 **Mórgan**[®]

Market Expansion
Services by
www.dksh.com



DKSH

E-mail: electrical.appliance@dksh.com