

Mórgan®

USER MANUAL

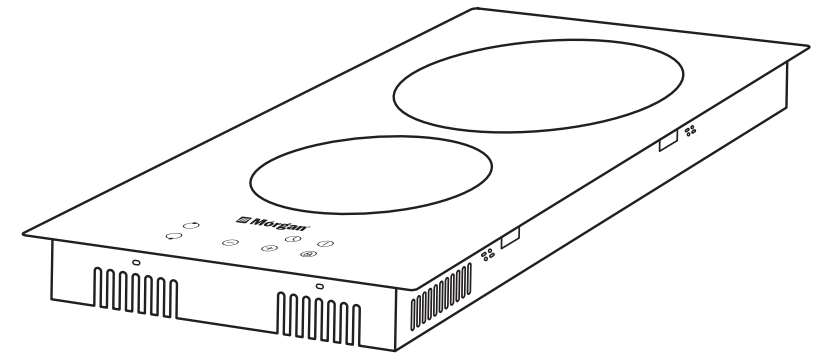

Mórgan®

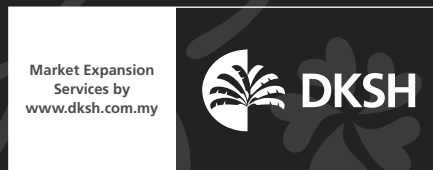

E-mail: electrical.appliance@dksh.com
www.morgan.my

 [facebook.com/morganappliances](https://www.facebook.com/morganappliances)

Ceramic Cooking Hob

MBH-CH30

C O N T E N T S

3	IMPORTANT SAFEGUARDS
4	GENERAL PRECAUTIONS
5	PRODUCT OVERVIEW
6	NOTES ON CERAMIC HOB
6	BEFORE FIRST USE
7	USING THE TOUCH CONTROLS
7	OPERATION INSTRUCTIONS
12	COOKING GUIDELINES
14	CARE AND CLEANING
15	TROUBLESHOOTING
16	INSTALLATION
18	CONNECTING THE HOB TO THE MAINS POWER SUPPLY
19	SPECIFICATIONS

Thank you for purchasing a quality MORGAN appliance. We trust that you will have a pleasant experience with your new product. To guarantee safety and best efficiency, please read this manual carefully and keep a copy for future reference.

IMPORTANT SAFEGUARDS

When using electric appliances, basic safety precautions should always be followed including the following:

IMPORTANT SAFETY INSTRUCTIONS

- Read these instructions carefully before installing or using this appliance.
- NEVER place combustible materials or products on this appliance at any time.
- This appliance must be installed according to these installation instructions to avoid the risk of electric shocks or fire.
- This appliance must be properly installed and earthed only by a suitably qualified person.
- This appliance should be connected to a circuit which incorporates an isolating switch providing full disconnection from the power supply.
- Failure to install the appliance correctly could invalidate any warranty or liability claims.
- Never leave the appliance unattended when in use. Boil overs can cause smoking and greasy spillovers that may ignite.
- Never use your appliance as a work or storage surface.
- Never leave any objects or utensils on the appliance cooktop.
- Never use your appliance for warming or heating the room.
- Always turn off the cooking zones and the cooktop after every use as described in this manual (i.e. by using the touch controls).
- Do not allow children to play with the appliance or sit, stand, or climb on it.
- Do not store children's items in cabinets above the appliance. Children climbing on the cooktop to reach these items could be seriously injured.
- Do not leave children alone or unattended when the appliance is in use.
- This appliance can be used by children aged from 8 years and above and persons with reduced physical, sensory or mental capabilities or lack of experience and knowledge if they have been given supervision or instruction concerning use of the appliance in a safe way and understand the hazards involved.
- Children should not perform cleaning and user maintenance without proper supervision.
- Do not repair or replace any part of the appliance unless specifically recommended in the manual. All other servicing should only be performed by a technician or similarly qualified person(s).
- Do not use a steam cleaner to clean your cooktop.
- Do not place or drop heavy objects on your cooktop.
- Do not stand on your cooktop.
- Do not use pans with jagged edges or drag pans across the glass surface as this can scratch the glass.
- Do not use scourers or any other harsh abrasive cleaning agents to clean your cooktop, as these can scratch the glass.
- If the supply cord is damaged, it must be replaced by the manufacturer, its service agent or similarly qualified persons in order to avoid a hazard.

IMPORTANT SAFEGUARDS

- This appliance is intended to be used in households and similar applications such as:
 - staff kitchen areas in shops, offices and other working environments;
 - farm houses;
 - by clients in hotels, motels and other residential type environments;
 - bed and breakfast type environments.
- **WARNING:** The appliance and its accessible parts become hot during use.
- Care should be taken to avoid touching heating elements.
- **WARNING:** Unattended cooking on a hob with fat or oil can pose a hazard and may result in fire. NEVER attempt to extinguish a fire with water, but switch off the appliance and then cover flame e.g. with a lid or a fire blanket.
- **WARNING:** Danger of fire: do not store items on the cooking surfaces.
- **WARNING:** If the surface is cracked, power off appliance to avoid the risk of electric shock as glass-ceramic hob surfaces or similar materials protect live parts
- The appliance is not intended to be operated by means of an external timer or separate remote-control system.
- **CAUTION:** The cooking process MUST be supervised. A short-term cooking process has to be supervised continuously.
- **WARNING:** to prevent the appliance from tipping over, a stabilizing means must be installed. Refer to the instructions for installation.
- **WARNING:** Use only hob guards designed by this cooking appliance's manufacturer or indicated by the appliance's manufacturer. Using incompatible hob guards may result in accidents.
- This appliance incorporates an earth connection for functional purposes only

GENERAL PRECAUTIONS

ELECTRICAL SHOCK HAZARD

- Connection to a good earth wiring system is essential and mandatory.
- Disconnect the appliance from the mains electricity supply before carrying out any work or maintenance on it.
- Alterations to the domestic wiring system must only be performed by a qualified technician.
- Failure to adhere to this advice may result in electrical shock or death.

CUT HAZARD

- Exercise extreme caution-panel edge saresharp.
- Failure to use caution could result in injury or cuts.

OPERATION AND MAINTENANCE ELECTRICAL SHOCK HAZARD

- Do not cook on a broken or cracked cooktop. If the cooktop surface breaks or cracks, switch the appliance off immediately at the power supply and contact a qualified technician.
- Switch the cooktop off at the power supply before performing cleaning or maintenance.
- Failure to comply with this advice may result in electrical shock or death.

GENERAL PRECAUTIONS

HEALTH HAZARD

- This appliance complies with electromagnetic safety standards.

HOT SURFACE HAZARD

- During use, accessible parts of this appliance will become hot enough to cause burns.
- Metallic objects such as knives, forks, spoons and lids should not be placed on the hob surface as they can get hot.
- Keep children away.
- Handles of saucepans may be hot to the touch. Ensure saucepan handles do not overhang other cooking zones that are on.
- Failure to follow this advice could result in burns and scalds.

CUT HAZARD

- The razor-sharp blade of the cooktop scraper is exposed when the safety cover is retracted. Use with extreme caution and always store safely and out of reach of children.
- Failure to use caution could result in injury or cuts.

PRODUCT OVERVIEW

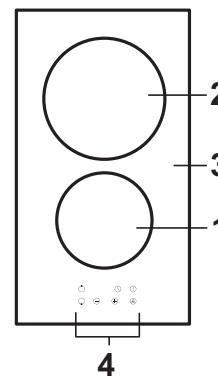

TOP VIEW

1. max. 1200 W zone
2. max. 1800 W zone
3. Glass plate
4. Control panel

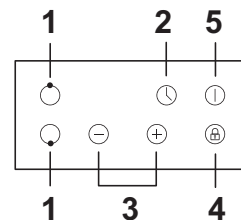

CONTROL PANEL

1. Heating zone selection controls
2. Timer control
3. Power / Timer regulating controls
4. Key lock control
5. ON/OFF control

NOTES ON CERAMIC HOB

- Ceramic hob cooking is based on infrared heating technology, where the nickel chrome wires of the hob radiate heat for cooking food.
- The hob offers safe and reliable performance, making your life comfortable and enabling to fully enjoy the pleasure from life.
- Ceramic hobs can use virtually all pots and pans, including woks, copper, stainless steel, cookware, glass, casserole and ceramic pots.

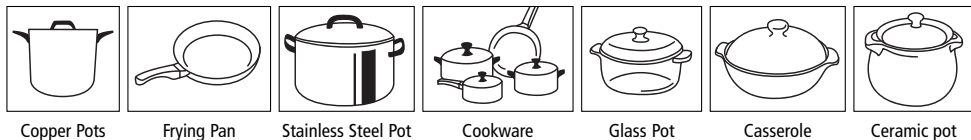

BEFORE FIRST USE

- Read this guide carefully, with special attention on the 'Safety Warnings' section.
- Remove any protective film that may still be on your hob.
- Do not use cookware with jagged edges or a curved base.



- Make sure that the base of your pan is smooth, sits flat against the glass, and is the same size as the cooking zone. Always centre your pan on the cooking zone.

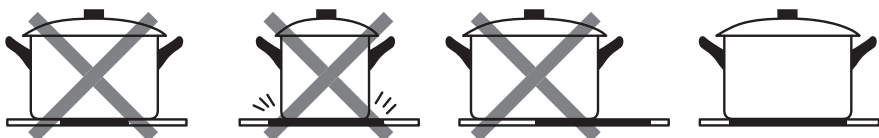

- Always lift pans off the hob – do not slide as they may scratch the glass.

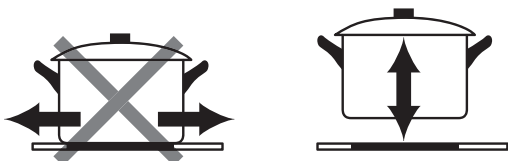

USING THE TOUCH CONTROLS

- The controls respond to touch without the need to apply any pressure.
- Use the ball of your finger and not the tip.
- A beep can be heard each time a touch is registered.
- Ensure controls are always clean, dry, and that there is no object (e.g. a utensil or a cloth) covering them.
- Even a thin film of water may make the controls difficult to operate.

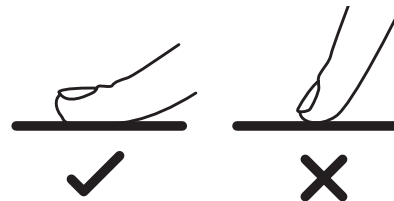

OPERATION INSTRUCTIONS

USING YOUR HOB

TO BEGIN COOKING

After power on, the buzzer beeps once, all the indicators will illuminate for 1 second, indicating that the hob is in state of standby mode.

1. Touch the ON/OFF control

After power on, the buzzer beeps once, all displays show "—" or "—", indicating that the ceramic hob has entered the state of standby mode.



2. Place a suitable pan on the cooking zone.

Ensure that the bottom of the pan and the surface of the cooking zone are clean and dry.

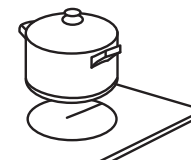

3. Touch the heating zone selection control, and the indicator next to the key will flash



4. Select a heat setting by touching the “-” or “+” control.

- If no heat setting is selected within 1 minute, the hob will automatically power off. You will need to start again at step 1.
- The heat setting can be altered at any time during cooking.
- Hold down either of the (-) or (+) buttons to adjust up or down.

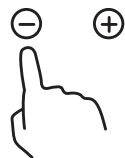

AFTER COOKING

1. Touch the heating zone selection control to power off.



2. Turn the cooking zone off by touching the “-” and scrolling down to “0”. Ensure the display shows “0”.



3. Power off the cooktop completely by touching the “ON/OFF” control.



4. Beware of hot surfaces

“H” will show which cooking zone is hot to touch. It will disappear when the surface has cooled down to a safe temperature. It can also be used as an energy saving function to heat other pans by using the hotplate that is still hot.



LOCKING THE CONTROLS



- You can lock the controls to prevent unintended use (for example children accidentally turning the cooking zones on).
- When the controls are locked, all the controls except the ON/OFF control are disabled.

TO LOCK THE CONTROLS

Touch the keylock control.  The timer indicator will display “Lo”.

TO UNLOCK THE CONTROLS

1. Ensure the hob is turned on.
2. Touch and hold the keylock control. 
3. The hob is now ready for use.

 When the hob is in the lock mode, all other controls are disabled except the ON/OFF  control. The ceramic hob can always be powered off with the ON/OFF control  during an emergency, but the hob should be unlocked first before the next operation.

OVER-TEMPERATURE PROTECTION

This appliance features a temperature sensor to monitor the temperature inside the hob. When excessive temperature is detected, the hob will halt all operation automatically.

RESIDUAL HEAT WARNING

When the hob has been operating for some time, there will be some residual heat. The letter “H” will appear on the cooktop to warn you to exercise caution.

AUTO SHUTDOWN PROTECTION

- Auto shut down is a safety protection function for your hob.
- It will shut down automatically whenever you forget to power off your cooking.
- The default shutdown times are shown in the table below:

Power level	1	2	3	4	5	6	7	8	9
Default working timer (hour)	8	8	8	4	4	4	2	2	2

USING THE TIMER

You can use the timer in two different ways:

- You can use it as a minute minder. In this case, the timer will not turn any cooking zone off when the set time is up.
- You can set it to turn one cooking zone off or more than one after the set time is up.
- You can set the timer for up to 99 minutes.

USING THE TIMER AS A MINUTE MINDER

IF YOU ARE NOT SELECTING ANY COOKING ZONE

- Ensure cooktop is turned on.
- NOTE:** The minute minder can be used even if cooking zones is not selected.
- Touch the timer control, the timer indicator show "30"



- Adjust the timer setting by touching the "-" or "+" controls. The minute minder indicator will start flashing and will show in the timer display.

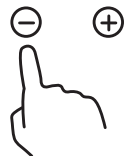

HINT:

- Touch the "-" or "+" timer control once to decrease or increase by 1 minute.
- Touch and hold the "-" or "+" timer control to decrease or increase by 10 minutes.
- If the set time exceeds 99 minutes, the timer will automatically return to 0 minute.

1. Touch the 'Timer', the timer is canceled, and the "00" will show in the minute display.



2. When the time is set, it will begin to count down immediately. The display will show the remaining time and the timer indicator will flash for 5 seconds.



3. The buzzer will beep for 30 seconds and the timer indicator will show "--" when the set time is achieved.

NOTE: The hob/cooktop will continue to cook as this timer function is only a minute minder and does not turn the cooktop ON or OFF.



SETTING THE TIMER TO TURN ONE COOKING ZONE OFF

1. Touch the heating zone selection control that you want to set the timer for. (e.g. zone 3#)

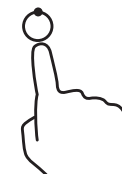

2. Touch timer control, the minder indicator will start flashing and "30" will show on the timer display.



Set the time by touching the "-" or "+" on the timer control.



HINT:

- Touch the "-" or "+" timer control once to decrease or increase by 1 minute.
 - Touch and hold the "-" or "+" timer control to decrease or increase by 10 minutes.
 - If the setting time exceeds 99 minutes, the timer will automatically return to 0 minute.
3. Touch the heating zone selection control and then the "Timer" will cancel the preset time. "00" will show in the minute display, and then "--".

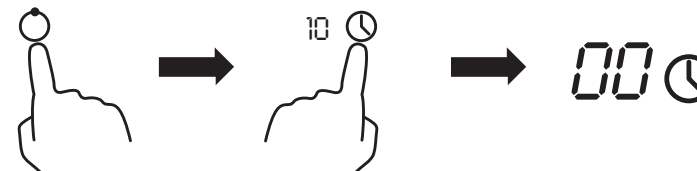

4. When the time is set, it will begin to count down immediately. The display will show the remaining time and the timer indicator flash for 5 seconds.



NOTE: The red dot next to power level indicator will illuminate indicating that zone is selected.



5. When cooking timer expires, the corresponding cooking zone will be switch off automatically and show "H".

NOTE: Other cooking zone will keep operating if they are turned on previously.

OPERATION INSTRUCTIONS

SETTING THE TIMER TO TURN MORE THAN ONE COOKING ZONE OFF

1. If more than one heating zone use this function, the timer indicator will show the lowest time.
(e.g. zone 1# setting time of 3 minutes, zone 2# setting time of 6 minutes, the timer indicator shows "3".)

NOTE: The red dot next to power level indicator will flash.



2. When cooking timer expires, the corresponding cooking zone will power off automatically and show "H".

NOTE: To change the time after the setting the timer - start from step 1 again.



COOKING GUIDELINES

COOKING TIPS

- When food comes to the boil, reduce the power setting.
- Using a lid will reduce cooking times and save energy by retaining the heat.
- Minimize the amount of liquid or fat to reduce cooking times.
- Start cooking on a high setting and lower the setting when the food has heated through

SIMMERING, COOKING RICE

- Simmering occurs below boiling point, at around 85 C, when bubbles are just rising occasionally to the surface of the cooking liquid.
- It is the key to delicious soups and tender stews because the flavour develops without overcooking the food.
- Egg-based and flour-thickened sauces are recommended for cooking below boiling point.
- Some tasks, including cooking rice by the absorption method, may require a setting higher than the lowest setting to ensure the food is cooked properly in the time recommended.

SEARING STEAK

To cook juicy flavoursome steaks:

1. Stand the meat at room temperature for about 20 minutes before cooking.
2. Heat up a heavy-based frying pan.
3. Brush both sides of the steak with oil. Drizzle a small amount of oil into the hot pan and then lower the meat onto the hot pan.
4. Turn the steak only once during cooking. The exact cooking time will depend on the thickness of the steak and how cooked you want it. Times may vary from about 2 – 8 minutes per side. Press the steak to gauge how its doneness – the firmer it feels the more 'well done' it will be.
5. Leave the steak to rest on a warm plate for a few minutes to allow it to relax and become tender before serving.

COOKING GUIDELINES

FOR STIR-FRYING

1. Choose a ceramic compatible flat-based wok or a large frying pan.
2. Have all the ingredients and equipment ready. Stir-frying should be quick. If cooking large quantities, cook the food in several smaller batches.
3. Preheat the pan briefly and add two tablespoons of oil.
4. Cook any meat first, put it aside and keep warm.
5. Stir-fry the vegetables. When they are hot but still crisp, turn the cooking zone to a lower setting, return the meat to the pan and add your sauce.
6. Stir the ingredients gently to make sure they are heated through.
7. Serve immediately.

HEAT SETTINGS

HEAT	GETTING SUITABILITY
1 – 2	<ul style="list-style-type: none"> • Delicate warming for small amounts of food • Melting chocolate, butter, and foods that burn quickly • Gentle simmering • Slow warming
3 – 4	<ul style="list-style-type: none"> • Reheating • Rapid simmering • Cooking rice
5 – 6	<ul style="list-style-type: none"> • Pancakes
7 – 8	<ul style="list-style-type: none"> • Sauteing • Cooking pasta
9	<ul style="list-style-type: none"> • Stir-frying • Searing • Bringing soup to the boil • Boiling water

CARE AND CLEANING

WHAT?	HOW?	IMPORTANT!
Everyday soiling on glass (fingerprints, marks, stains left by food or non-sugary spillovers on the glass)	<ol style="list-style-type: none"> 1. Power off cooktop. 2. Apply a cooktop cleaner while the glass is still warm (but not hot!) 3. Rinse and wipe dry with a clean cloth or paper towel. 4. Switch the power to the cooktop back on. 	<ul style="list-style-type: none"> • When cooktop is powered off, there will be no 'hot surface' indication but the cooking zone may still be hot! Exercise extreme caution. • Heavy-duty scourers, nylon scourers and harsh/abrasive cleaning agents may scratch the glass. Always read the label to check if your cleaner or scourer is suitable. • Never leave cleaning residue on the cooktop: the glass may become stained.
Boil-overs, melts, and hot sugary spills on the glass	<ol style="list-style-type: none"> 1. Remove these immediately with a scraper suitable for ceramic glass cooktops, but beware of hot cooking zone surfaces: 2. Disconnect appliance from the power supply. 3. Hold the scraper or utensil at a 30° angle and scrape the soiling or spill to a cool area of the cooktop. 4. Clean the soiling or spill up with a dish cloth or paper towel. 5. Follow steps 2 to 4 for 'Everyday soiling on the above of the glass. 	<ul style="list-style-type: none"> • Remove stains left by melts and sugary food or spillovers as soon as possible. If left to cool on the glass, they may be difficult to remove or even permanently damage the glass surface. • Cut hazard: when the safety cover is retracted, the blade in a scraper is razor-sharp. Use with extreme caution and always keep out of children's reach.
Spillovers on the touch controls	<ol style="list-style-type: none"> 1. Power off the cooktop. 2. Soak up the spill 3. Wipe the touch control area with a clean damp sponge or cloth. 4. Wipe the area completely dry with a paper towel. 5. Switch the power to the cooktop back on. 	<ul style="list-style-type: none"> • The cooktop may beep and turn itself off, and the touch controls may not function while there is liquid on them. Be sure to wipe the touch control area dry before powering the cooktop back on.

TROUBLESHOOTING

PROBLEM	POSSIBLE CAUSE(S)	SOLUTION
The cooktop cannot be turned on.	No power.	<ul style="list-style-type: none"> • Ensure cooktop is connected to the power supply and that it is switched on. • Check whether there is a power outage in your home or area. If you've checked everything and the problem persists, call a qualified technician.
The touch controls are unresponsive.	The controls are locked.	<ul style="list-style-type: none"> • Unlock the controls (See section 'Using your hob' for instructions).
The touch controls are difficult to operate.	There may be a slight film of water over the controls or you may be using the tip of your finger when touching the controls.	<ul style="list-style-type: none"> • Ensure the touch control area is dry and use the ball of your finger when touching the controls.
The glass is scratched.	Rough-edged cookware. The use of incompatible, abrasive scourer or cleaning products.	<ul style="list-style-type: none"> • Use cookware with flat and smooth bases. (See 'Choosing the right cookware'). • See 'Care and cleaning'.
Some pans make crackling or clicking noises.	This may be caused by the construction of your cookware (layers of different metals vibrating differently).	<ul style="list-style-type: none"> • This is normal for cookware and does not indicate a fault.
The hob makes a low humming noise when a high heat setting is selected.	This is caused by the technology of cooking.	<ul style="list-style-type: none"> • This is normal, but the noise should quieten down or disappear completely heat setting is decreased.
Pans do not heat up and do not appear in the display.	<p>Unsuitable pan used for cooking.</p> <p>The hob cannot detect the pan because it is too small for the cooking zone or not properly centered on it.</p>	<ul style="list-style-type: none"> • Use cookware suitable for cooking. (See section 'A Word on Ceramic Hob'). • Centre the pan and ensure its base matches the size of the cooking zone.
The hob or a cooking zone has turned itself off unexpectedly, a tone sounds and an error code is displayed (typically alternating with one or two digits in the cooking timer display).	Technical fault.	<ul style="list-style-type: none"> • Jot down the error letters and numbers, switch the power to the ceramic hob off at the wall, and contact a qualified technician.

INSTALLATION

SELECTION OF INSTALLATION EQUIPMENT

Cut out the work surface according to the sizes shown in the drawing.

For the purpose of installation and use, a minimum of 50mm space shall be preserved around the hole.

Ensure the thickness of the work surface is at least 30mm. Use heat-resistant work surface materials to avoid larger deformation caused by the heat radiation from the hotplate as shown below:

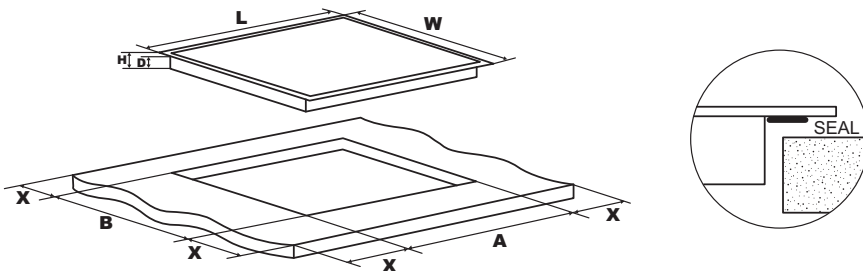

L (mm)	W (mm)	H (mm)	D (mm)	A (mm)	B (mm)	X (mm)
288	520	52	48	268	500	50 mini.

Under all circumstances, ensure that the ceramic hob is well ventilated and the air inlet and outlet are not blocked. Ensure the ceramic hob is in good working condition.

Note: The safety distance between the hotplate and the cupboard above the hotplate should be at least 760mm.

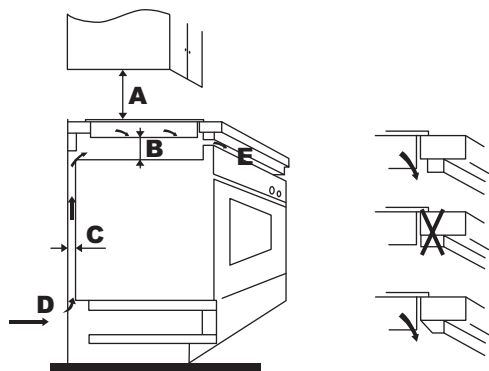

A (mm)	B (mm)	C (mm)	D	E
760	50	30	Air Intake	Air Exit 10 mm

INSTALLATION

BEFORE LOCATING THE FIXING BRACKETS

The unit should be placed on a stable, smooth surface (use the packaging). Do not apply force onto the controls protruding from the hob.

Secure the hob on the work surface by screwing four brackets on the bottom of hob (see picture) after installation.

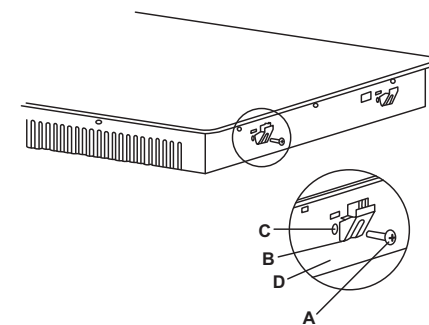

- A. Screw
- B. Bracket
- C. Screw Hole
- D. Base

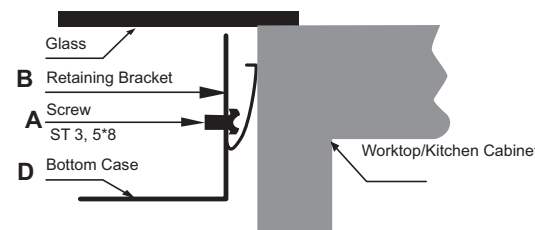

CAUTION

1. The ceramic hob must be installed by qualified technicians or similarly qualified personnel. Never attempt to perform the installation yourself.
2. Never mount the ceramic hob onto cooling equipment, dishwashers and rotary dryers.
3. The ceramic hob shall be installed such that better heat radiation can be ensured to enhance its reliability.
4. The wall and induced heating zone above the work surface shall withstand heat.
5. To avoid any damage, the sandwich layer and adhesive must be heat-resistant.
6. Do not use a steam cleaner.
7. This ceramic hob can be connected only to a supply with system impedance not exceeding 0.427 ohm. If necessary, please consult your supply authority for system impedance information.



This hob must be connected to the power supply only by a technician or suitably qualified person. Before connecting the hob to the power supply, ensure that:

1. the domestic wiring system is suitable for the power drawn by the hob.
2. the voltage corresponds to the value given in the rating plate
3. the power supply cable sections can withstand the load specified on the rating plate.



To connect the hob to the mains power supply, do not use adapters, reducers, or branching devices, as they can cause overheating and fire.

The power supply cable must not touch any hot parts and must be positioned so that its temperature will not exceed 75°C at any point.

Check with an electrician whether the domestic wiring system is suitable without alterations.

Any alterations must only be made by a qualified electrician.

The power supply should be connected in compliance with the relevant standard, or a single-pole circuit breaker. The method of connection is shown below.

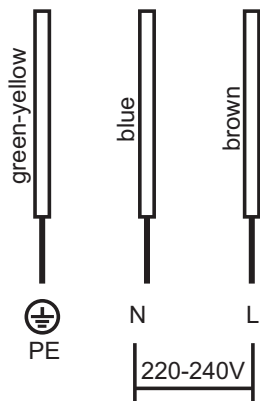

1. If the cable is damaged or needs replacing, this should be performed by an after-sales technician with the proper tools to avoid any accidents.
2. If the appliance is being connected directly to the mains supply, an omnipolar circuit breaker must be installed with a minimum gap of 3mm between the contacts.
3. The installer must ensure that the correct electrical connection has been made and that it complies with safety regulations.
4. The cable must not be bent or compressed.
5. The cable must be checked regularly and only replaced by a technician or suitably qualified person.

MODEL	MBH-CH30
RATED VOLTAGE / FREQUENCY	220-240V~ 50-60Hz
RATED WATTAGE	2745-3267W
COOKING ZONES	2 ZONES
PRODUCT SIZE (mm)	288L x 520W x 52H
BUILT-IN DIMENSIONS AxB (mm)	268 x 500



DISPOSAL: Do not dispose this product as unsorted municipal waste. Collection of such waste separately for special treatment is necessary.

This appliance is labeled in compliance with European directive 2012/19/EU for Waste Electrical and Electronic Equipment (WEEE). By ensuring that this appliance is disposed of correctly, you will help prevent any possible damage to the environment and to human health, which might otherwise be caused if it were disposed of in the wrong way.

The symbol on the product indicates that it may not be treated as normal household waste. It should be taken to a collection point for the recycling of electrical and electronic goods.

This appliance requires specialist waste disposal. For further information regarding the treatment, recover and recycling of this product please contact your local council, your household waste disposal service, or the shop where you purchased it.

For more detailed information about treatment, recovery and recycling of this product, please contact your local city office, your household waste disposal service or the shop where you purchased the product.